



# GROOVED COUPLINGS AND FITTINGS

we are a leading  
invisible grooved  
couplings  
and fittings  
Supplier in India.

OFFERED BY  
'SKS VALVES'

**SKS**

# COMPANY PROFILE

CNG Grooved products are very good quality piping products.

equipped with most advanced casting, milling, painting and assembling facilities, including 3 DISA automatic molding line, semi-automatic casting machine, precision casting line, large size floor molding system and relevant comprehensive testing equipment.

Multiple markets served, Our piping systems are found worldwide in multiple applications- from commercial comfort piping systems; industrial process and utility piping; petrochemical and metallurgy industries; coal and mineral mining operations; water and wastewater plants, and facilities.

## Certificates & approvals

- CNG brand Grooved products are designed, manufactured,
- managed strictly by the ISO quality management system
- C1SO 9001:2000 Quality Management System certificated
- C1SO 14001 Environmental Management System certificated
- COHSAS 18001 Occupational Health and Safety Assessment
- Series certificated
- CcULus(UL/cUL listed and FM approved
- CVdS and LPC approvals are under process.
- CNG Grooved Fitting are Marketed by **SKS**

## APPLICATION FIELDS

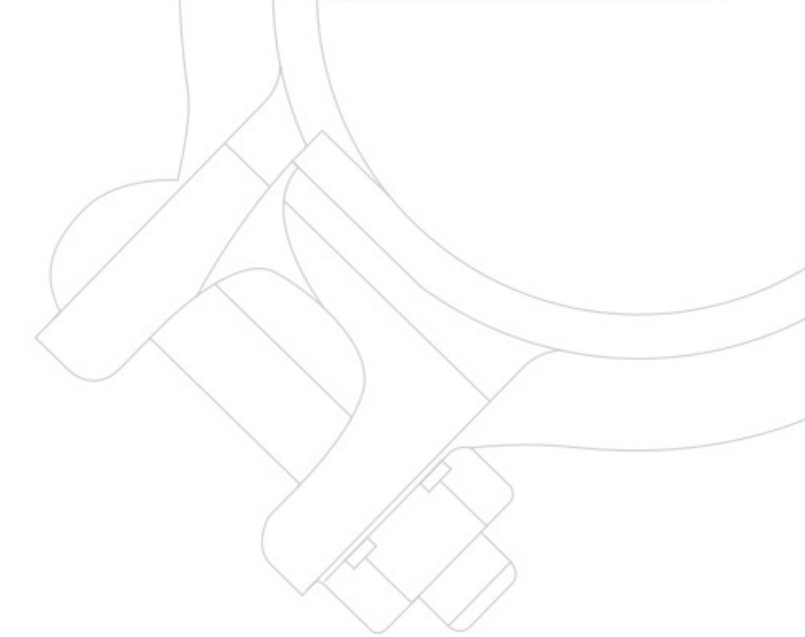

## CONTENT

- Brief Description.....1 - 2
- Application Field .....3
- Products Equipment..... 4
- Products Futures.....5 - 7
- Grooved Couplings.....8 - 12
- Grooved Fitting.....13 - 21
- Mechanical Outlate.....22 - 25
- Rubber Gasket.....26
- Pipe Preparations.....27



# OFFERED BY 'SKS' VALVES

## PRODUCTION EQUIPMENT

CNG Grooved piping system is reliable and is faster to install than welding, threading, or flanging, resulting in the lowest installed cost. It can be adapted to suit standard pipe with cut grooves or standard and light wall pipe with rolled grooves. Couplings perform equally well under pressure and vacuum. Couplings are available for flexible and rigid systems.



PRODUCTION EQUIPMENT

GROOVED COUPLING AND FITTINGS 3-4



## Products Type

CNG grooved piping system covers following categories:

- **Grooved Couplings**

Grooved couplings are designed as a ring self-centering connector, the inner key area of the housing engages in the pipe grooves to provide a pipe connection. When the flexible coupling is assembled in the pipeline, a gap is formed between the pipe ends to allow axial displacement and lateral deflection. Rigid coupling locks the pipes directly without deflection.

- **Mechanical Outlets**

The housing of branch outlet fittings has two different parts, respectively, the outlet housing and the cover. The mechanical outlets can be composed of two outlet housing (said the mechanical cross), or one outlet housing plus one cover (said as mechanical tee). The outlet housing is designed as a self-positioning structure, to build a branch outlet on the main pipe run.

- **Grooved Non-Gasket Fittings**

Grooved fittings have a variety of styles, to provide flow direction turning, diameter reducing, branching and other functions.

## Products Component

- **Housing**

Material : Ductile cast iron conforming to ASTM A-536, Grade 65-45-12.

Surface Finish : Standard : Epoxy powder coating

Optional : Galvanized (Zinc Plated, HDG), Dip painted

Surface Color : Variable colors for choice

- **Rubber Gasket**

Standard: EPDM.

Optional : Nitrile, Silicone, Fluoroelastomer, Neoprene

The sealing mechanism of grooved couplings and mechanical outlets is basically the same, the main structure of the gasket has "C" shape, forming a triple seal function. The first seal is formed by the elasticity of the gasket during the static state. After the coupling is installed, the gasket is confined by the housing of groove coupling or the mechanical outlet, the second seal is formed. Medium inside the pipe system press the "C" cavity after pressurizing, it increases the adhesion between gasket lip and steel pipe surface, so as to achieve the third reactive seal. The greater the pressure of the fluid within the pipe, The better the sealing of the coupling.



The material of the gasket must be chosen to follow the characteristics of the fluid medium below. The commonly used gasket are shown in the following table:

Grade	Temperature Range	Rubber Compound	Color Code	General Service Recommendations
E	-30°F to +230°F -34°C to +110°C	EPDM	Green Stripe	Recommended for hot water service within the specified temperature range plus a variety of dilute acids, oil-free air and many chemical services. UL classified in accordance with ANSI/NSF 61 for cold +86°F/+30°C and hot +180°F/+82°C potable water service. <b>NOT RECOMMENDED FOR PETROLEUM SERVICES.</b>
T	-20°F to +180°F -29°C to +82°C	Nitrile	Orange Stripe	Recommended for petroleum products, hydrocarbons, air with oil vapors, vegetable and mineral oils within the specified temperature range; except hot dry air over +140°F/+60°C and water over +150°F/+66°C. <b>NOT RECOMMENDED FOR HOT WATER SERVICES.</b>
O	-20°F to +300°F -29°C to +149°C	Fluoroelastomer	Blue Stripe	Recommended for many oxidizing acids, petroleum oils, halogenated hydrocarbons, lubricants, hydraulic fluids, organic liquids and air with hydrocarbons to +300°F/+149°C.
L	-30°F to +350°F -34°C to +177°C	Silicone	Body white	Recommended for dry heat, air without hydrocarbons to +350°F/+177°C and certain chemical services.
V	-30°F to +180°F -34°C to +82°C	Neoprene	Yellow Stripe	Recommended for hot lubricating oils and certain chemicals. Good oxidation resistance. Will not support combustion.

For specific compound and temperature compatibility, see this book Chemical Application Table

- **Bolt/Nut**

Heat treated and electro galvanized bolts with oval neck, and heavy duty hexagon nuts.

Track head meeting the physical and chemical requirements of ASTM A-449 and physical requirements of ASTM A-183.

## Grooved Couplings



As the manufacturer and innovator of grooved coupling technology, CNG offers a variety of coupling sizes and styles for almost any piping application.

All grooved couplings are made up of four parts, namely housing, gasket, bolt and nut. Housing is made of ductile iron, surface finish is orange, but also for a variety of fluid piping system to provide matching color scheme; standard gasket material is EPDM, also prepared for a variety of pipeline media rubber material. The bolt's tensile rating is class 8.8 and the nut's rating 8.0.

CNG couplings provide pipe system with versatility not found in other pipe connection methods. CNG rigid and flexible couplings can be combined to allow for thermal growth within the system. Additionally, the use of three consecutive flexible couplings reduces noise and vibration and eliminates costly noise dampeners.



Style 1GS Rigid Coupling  
DN25~DN300 1"~12"  
33.4mm~323.9mm



Style 1X Angle-pad Rigid Coupling  
DN25~DN300 1"~12"  
33.4mm~323.9mm



Style 1N Flexible Coupling  
DN25~DN300 1"~12"  
33.4mm~323.9mm

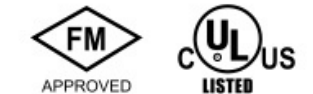

Style 1NH H.D. Flexible Coupling  
DN25~DN300 1"~12"  
33.4mm~323.9mm



Style 1NR Reducing Flexible Coupling  
DN32~DN200 1 1/4"~8"  
42.4mm~219.1mm



Style 321 Split Flange Adaptor  
DN50~DN200 2"~8"  
60.3mm~219.1mm

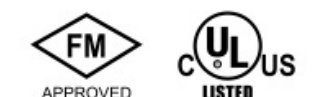



Design Date

Design Date

## Introduction

This CNG General Catalog has been written for the piping system installer, designer, specification writer and owner as a basic reference guide for data about CNG mechanical piping methods. This catalog is organized to provide information in the context and form most readily usable. For easy identification of major sections of interest, see the condensed table of contents, for a fully detailed index. For more detailed information, consult Design Data.

## Important Information

After more than a decade of experience in grooved-connected pipelines, CNG has developed multi-gauge and multi-pressure ratings of grooved products for use with different pipe materials.

CNG standard grooved piping system products are designed for use only with pipes and fittings that conform to the global groove standard as AWWA C606. Piping must be prepared in accordance with the groove specifications published by CNG and the performance data listed in this catalog is based on the correct preparation of the piping. In particular, installer must choose the right rubber seal material to suit applications. It should be noted that some special applications are not recommended to use the standard sealing material. Please refer to the "Rubber Gasket" section of this catalog for a list of applications where rubber sealant materials are recommended, as well as applications not recommended for use. CNG rubber gasket must be lubricated to facilitate proper installation and use. The seal lubricant must comply with CNG regulations or approval. Fully lubricate the outer surface of the gasket, including the lips and tube ends, and the housing cavity for lubrication, which will help prevent the rubber gasket from crinkling during installation.

## Notice

The technical and performance data, weights, dimensions and specifications published in this catalog supersede all previously published data.

CNG Company maintains a policy of continual product improvement and, therefore, reserves the right to change product specifications, designs, and standard equipment without notice and without incurring obligation.

For the most up-to-date CNG product information, please visit [www.cngruv.cn](http://www.cngruv.cn). All data & information presented in this catalog is intended for piping design reference in utilization of CNG products for their intended application. It is not intended as a substitute for competent, professional assistance which is an obvious requisite to any specific application.

## Design

Reference should always be made to design information available at no charge on request from CNG. Good piping practices should always prevail. Specific pressures, temperatures, external or internal loads, performance standards and tolerances must never be exceeded. Many applications require recognition of special conditions, code requirements and use of safety factors. Qualified engineers must make these decisions.

While every effort has been made to ensure its accuracy, CNG Company, its subsidiaries and affiliated companies, make no express or implied warranty of any kind respecting the information contained in this catalog or the material referred to herein.

Anyone making use of the information or material contained herein does so at their own risk and assumes any and all liability resulting from such use.

## Designations of global pipe sizes

CNG product data is utilized worldwide and all technical data is shown in both imperial (U.S.) and metric terms. The following chart shows a comparison between typical metric and IPS pipe sizes.

Size		Design Date	ISO	ANSI	BS	DIN	JIS	GB
Nominal Dia.		Actual O.D.	Actual O.D.	Actual O.D.	Actual O.D.	Actual O.D.	Actual O.D.	Actual O.D.
Metric	Inches	Metric mm	Metric mm	Metric mm	Metric mm	Metric mm	Metric mm	Metric mm
15	1/2	21.3	21.3	21.3	21.3	21.3	21.7	21.3
20	3/4	26.9	26.9	26.7	26.9	26.9	27.2	26.9
25	1	33.4	33.7	33.4	33.7	33.7	34.0	33.7
32	1 1/4	42.4	42.4	42.2	42.4	42.4	42.7	42.4
40	1 1/2	48.3	48.3	48.3	48.3	48.3	48.3	48.3
50	2	54.0	-	-	-	-	-	54.0
		57.0	-	-	-	-	-	57.0
		60.3	60.3	60.3	60.3	60.3	60.5	60.3
65	2 1/2	73.0	-	73.0	-	-	-	73.0
		76.1	76.1	-	76.1	76.1	76.3	76.1
80	3	88.9	88.9	88.9	88.9	88.9	89.1	88.9
90	3 1/2	101.6	-	101.6	101.6	101.6	101.5	102.0
100	4	108.0	-	-	-	-	-	108.0
		114.3	114.3	114.3	114.3	114.3	114.3	114.3
120	4 1/2	127.0	-	127.0	-	-	-	127.0
125	5	133.0	-	-	-	-	-	133.0
		139.7	139.7	-	139.7	139.7	139.8	139.7
		141.3	-	141.3	-	-	-	141.3
150	6	152.4	-	152.4(60D)	-	-	-	152.0
		159.0	-	-	-	-	-	159.0
		165.1	-	-	165.1	-	165.2	165.1
		168.3	168.3	168.3	-	168.3	-	168.3
175	7	194.0	-	193.7	193.7	193.7	-	194.0
200	8	203.2	-	203.2(80D)	-	-	-	203.0
		216.3	-	-	-	-	216.3	-
		219.1	219.1	219.1	219.1	219.1	-	219.1
225	9	241.8	-	-	-	-	241.8	-
		245.0	-	245.0	-	-	-	245.0
250	10	254.0	-	254.0(100D)	-	-	-	-
		267.4	-	-	-	-	267.4	267.0
		273.0	273.0	273.0	273.0	273.0	-	273.0
275	11	299.1	-	299.1	-	-	-	299.0
300	12	304.8	-	304.8(120D)	-	-	-	-
		318.5	-	-	-	-	318.5	318.5
		323.9	323.9	323.9	323.9	323.9	-	325.0
350	14	355.6	355.6	355.6	355.6	355.6	355.6	356.0
		377.0	-	-	-	-	-	377.0
400	16	406.4	406.4	406.4	406.4	406.4	406.4	406.0
		426.0	-	-	-	-	-	426.0
450	18	457.2	457.2	457.2	457.2	457.2	457.2	457.0
		480.0	-	-	-	-	-	480.0
500	20	508.0	508.0	508.0	508.0	508.0	508.0	508.0
		530.0	-	-	-	-	-	530.0
550	22	558.8	-	558.8	559.0	558.8	558.8	560.0
600	24	609.6	610.0	609.6	610.0	609.6	609.6	610.0
		630.0	-	-	-	-	-	630.0
700	28	711.2	711.0	711.2	711.0	711.2	711.2	711.0
		720.0	-	-	-	-	-	720.0
800	32	812.8	813.0	812.8	813.0	812.8	812.8	813.0
900	36	914.4	914.0	914.4	914.0	914.4	914.4	914.0
1000	40	1016.0	1016.0	1016.0	1016.0	1016.0	1016.0	1016.0
1050	42	1066.8	1067.0	1066.8	-	1066.8	-	1067.0
1100	44	1117.6	1118.0	1117.6	-	1117.6	1117.6	1118.0
1200	48	1219.2	-	1219.2	-	1219.2	1219.2	1219.0



Design Date

Products Features

## Metric / Inch Conversion Chart

This chart is provided as a guide for converting imperial and metric measurements provided within this catalog.

	Metric		Conversion		Conversion	Inch
Length	mm	X	0.03937	⇔	25.4	X In
	m	X	3.28084	⇔	0.3048	X Feet(ft.)
	km	X	0.621371	⇔	1.609344	X mile
Area	mm <sup>2</sup>	X	0.00155	⇔	645.16	X in <sup>2</sup>
	m <sup>2</sup>	X	10.7639	⇔	0.0929	X ft <sup>2</sup>
LIQUID	m <sup>3</sup>	X	264.172	⇔	0.0037854	X usgal
	m <sup>3</sup>	X	61023.7	⇔	0.0000164	X In. <sup>3</sup>
	m <sup>3</sup>	X	35.303	⇔	0.02832	X ft <sup>3</sup>
Pressure	kpa	X	0.145	⇔	6.8948	X PSI
	kpa	X	0.01	⇔	100	X bar
	bar	X	14.5	⇔	0.068948	X PSI
Temperature	°C	X	°C X 1.8 +32	⇔	(°F-32)/1.8	X °F
Torque	N-m	X	0.7375	⇔	1.356	X ft-lbf
Force	N	X	0.2248	⇔	4.4482	X lbs.
	kg	X	2.2026	⇔	0.4536	X lbs.
Mass	g	X	0.035274	⇔	28.3495	X oz.
	kg	X	2.2026	⇔	0.4536	X lbs.
Power	W	X	0.001341	⇔	745.7	X hp
	W	X	0.737562	⇔	1.35582	X ft-lbf/s
Quantity of Flow	L/min	X	0.2642	⇔	3.785	X Gal. per Min. (GPM)
	m <sup>3</sup> /min	X	264.2	⇔	3.7865	X 10 <sup>3</sup> Gal. per Min.(GPM)

## Products Presentation

Three traditional methods to connect steel pipes, namely welding, flange connection and screw connection.

CNG grooved piping system use the grooved couplings & branch outlet fittings as the key, supplemented by a variety of non-gasket pipefittings. This is a pipe connection revolution. At present, CNG manufactures all kinds of grooved branch outlet fittings and non-gasket fittings. In order to meet the needs of customers, CNG also developed extended products such as grooved end valves, filters, etc. CNG will continue to improve and optimize so that the company's product line can fulfill demands in civil construction, municipal and industrial fields..

CNG groove piping system is an universal, economic, safe and practical piping system components, the installation process will not bring any pollution to the pipeline. It is an environmentally friendly green product.

CNG groove piping system builds pipe connection on the external surface of steel pipes. The inner diameter & interior surface of the pipe has no matter of the connection, which makes the range of application of this product much more extended.

## Products Strong Point

Compared with the traditional piping methods such as welded, flanges or threaded connection, the grooved and mechanical outlet fittings has very significant advantages, mainly in the following aspects:

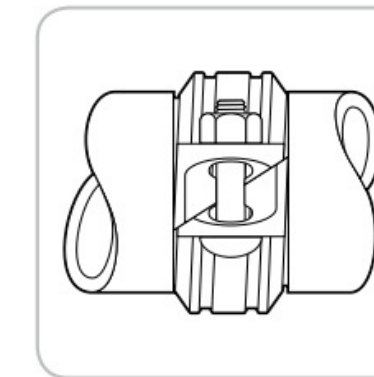

◆ Rigid  
Rigid coupling provides enough rigidity to resist tube twisting and bending moment.

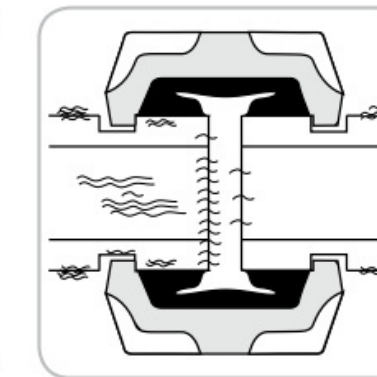

◆ Noise and vibration  
The separation between pipe ends reduces the transmission of noise and vibration, provides the entire system a significant dampening effect

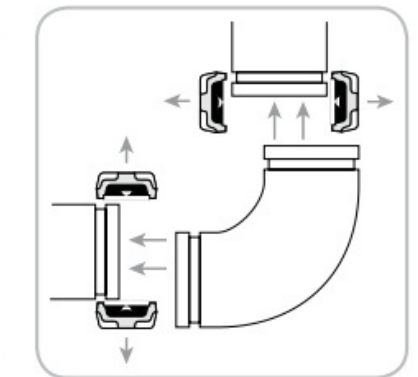

◆ system maintenance  
System unit can be disassembled without moving the pipeline, thus facilitating system maintenance and modification.

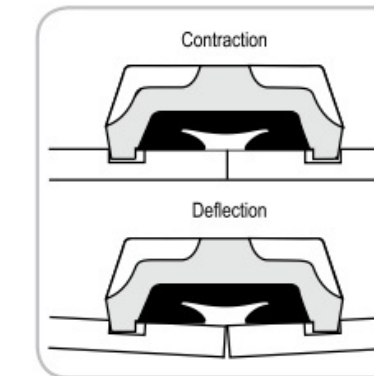

◆ Flexibility  
Flexible coupling provides radial and axial deflection. It absorbs expansion, contraction, deflection and vibration.

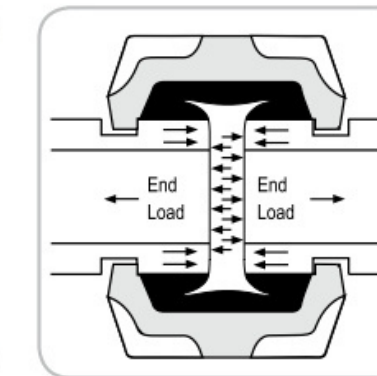

◆ Earthquake stress  
The full circumferential engage between couplings keys and pipe grooves provides sufficient internal pressure and pipe end load capacity to withstand pipe movement.

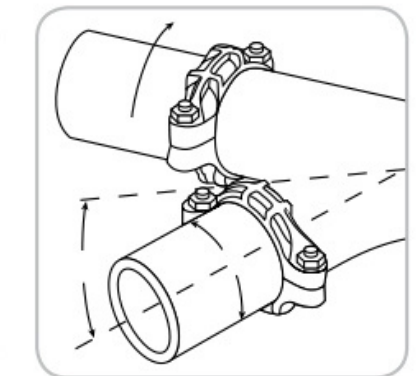

◆ Easy alignment  
Groove system allows free rotation of pipe and system components prior final fixing.

**Warning**

Before attempting to install, disassemble, and adjust any CNG product, please depressurize and drain the plumbing system. Failure to do this may result in personal injury, property damage, leaks, and / or other potential function failure.

## Rubber Gasket Types

Rubber Gasket Types		Style 1GS	Style 1X	Style 1N	Style 1NR	Style 321
CG1		*	*	*		
RCG1					*	
CG4		*	*	*		
FG1						*

## Rigid coupling connection & performance

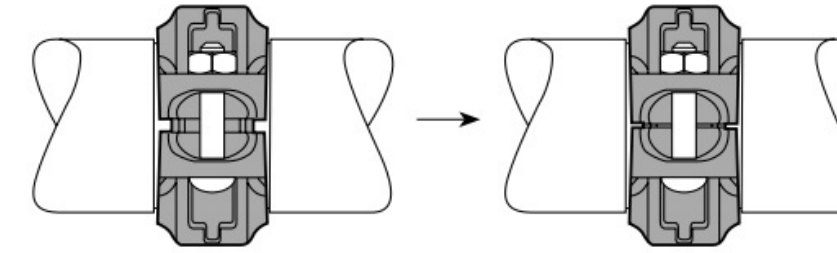

The structure of the socket type rigid coupling is compact, with the inner and outer female and male teeth, socket type, meshing design, the use of the gap between the female and male port socket combination of pipe and joint meshing to achieve the rigid requirements.

Due to the improved interface structure, it is not easy to make the gasket to produce transverse and oblique twists and turns, the positioning of the gasket is more accurate, the abnormal pressing and destructive pressure loss of the gaskets are avoided, the sealing property is increased, and the overall joint is increased service life.

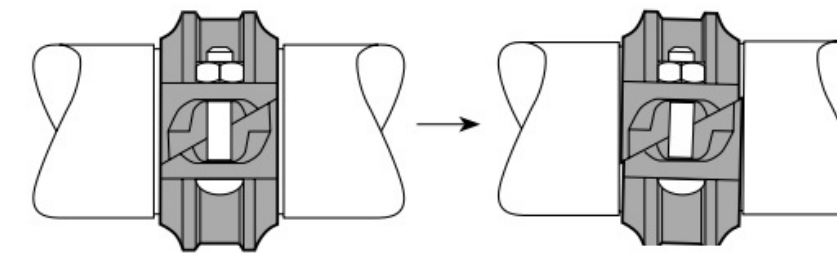

The Angle-pad rigid coupling is designed to sliding rather than vertical moving when tightening the housing. So the pipe tightly stuck to form a rigid connection. This 60°diagonal sliding also forces the coupling housing keys to make double sided contact on the inside and outside edges of the groove so that axial and radial movement of the tube cannot occur and the effect of rigid connecting pipe is truly achieved. No deflection after installation.

This rigid coupling allows for more accurate positioning of the tube end forming a fixed tube end separation that should be considered in the design and installation (see the following list of parameters).

### Allow. Pipe End Sep.

Size		Allow. Pipe End Sep.	
Nominal Dia.	Actual O.D.	Style 1GS	Style 1X
DN	mm	mm	mm
Inches	Inches	Inches	Inches
25	33.4	2.3	2.2
1	1.315	0.091	0.087
32	42.4	2.3	2.2
1 1/4	1.660	0.091	0.087
40	48.3	2.3	2.2
1 1/2	1.900	0.091	0.087
50	60.3	2.3	2.2
2	2.375	0.091	0.087
65	73.0	2.3	2.7
2 1/2	2.875	0.091	0.106
65	76.1	2.3	2.7
2 1/2	3.000	0.091	0.106
80	88.9	2.7	2.7
3	3.500	0.106	0.106
100	108.0	2.7	3.3
4	4.250	0.106	0.130
100	114.3	2.7	3.3
4	4.500	0.106	0.130

Size		Allow. Pipe End Sep.	
Nominal Dia.	Actual O.D.	Style 1GS	Style 1X
DN	mm	mm	mm
Inches	Inches	Inches	Inches
125	133.0	2.7	3.3
5	5.250	0.106	0.130
125	139.7	2.7	3.3
5	5.500	0.106	0.130
125	141.3	2.7	3.3
5	5.563	0.106	0.130
150	159.0	2.7	3.3
6	6.250	0.106	0.130
150	165.1	2.7	3.3
6	6.500	0.106	0.130
150	168.3	2.7	3.3
6	6.625	0.106	0.130
200	219.1	4.9	4.9
8	8.625	0.193	0.193
250	273.0	4.9	4.9
10	10.750	0.193	0.193
300	323.9	4.9	4.9
12	12.750	0.193	0.193

- Rigid couplings cannot be used to absorb any piping system movement.
- For the absorption of pipe system movement, please use flexible couplings.

## Flexible Coupling Systems & Performance

Using of flat joint design, flexible coupling keeps a separation between pipe ends to achieve flexibility of pipeline. This structure ensures the strength without fully holding the pipes, allows axial and radial displacement, suitable for deflection requirements of the pipeline. The flexible coupling is designed to absorb the deviation of the pipe outer diameter without affecting the joint performance

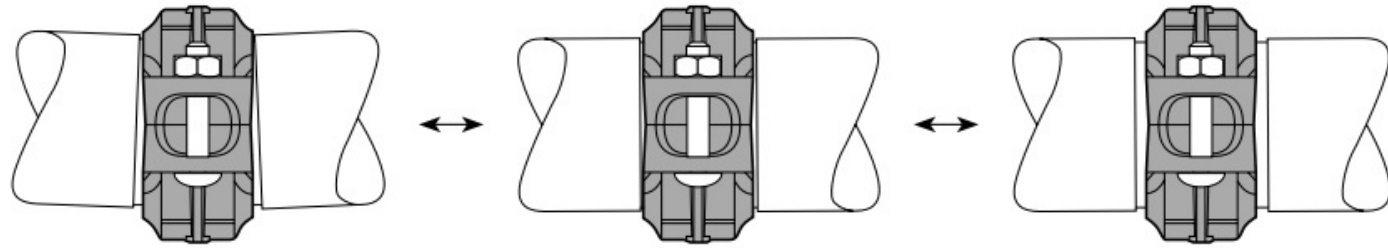

### Allow. Pipe End Sep. & Flexibility

Size		Allow. Pipe End Sep.	Flexibility		Size		Allow. Pipe End Sep.	Flexibility	
Nominal Dia.	Actual O.D.		Max. Degrees	Misalignment	Nominal Dia.	Actual O.D.		Max. Degrees	Misalignment
DN Inches	mm Inches	mm Inches	Degree(°)	mm/m In./Ft.	DN Inches	mm Inches	mm Inches	Degree(°)	mm/m In./Ft.
25 1	33.4 1.315	2.2 0.087	2.7	47 0.57	125 5	133.0 5.250	3.6 0.142	1.3	22 0.27
32 1 1/4	42.4 1.660	2.2 0.087	2.2	38 0.46	125 5	139.7 5.500	3.6 0.142	1.3	22 0.27
40 1 1/2	48.3 1.900	2.2 0.087	2.0	34 0.42	125 5	141.3 5.563	3.6 0.142	1.3	22 0.27
50 2	60.3 2.375	2.2 0.087	1.9	33 0.40	150 6	159.0 6.250	3.9 0.154	1.1	19 0.23
65 2 1/2	73.0 2.875	2.4 0.094	1.8	31 0.38	150 6	165.1 6.500	3.9 0.154	1.1	19 0.23
65 2 1/2	76.1 3.000	2.4 0.094	1.8	31 0.38	150 6	168.3 6.625	3.9 0.154	1.1	19 0.23
80 3	88.9 3.500	2.8 0.110	1.7	29 0.36	200 8	219.1 8.625	4.9 0.193	0.85	14 0.18
100 4	108.0 4.250	3.3 0.130	1.6	27 0.34	250 10	273.0 10.750	4.9 0.193	0.67	11 0.14
100 4	114.3 4.500	3.3 0.130	1.6	27 0.34	300 12	323.9 12.750	4.9 0.193	0.58	10 0.12

- All the parameters in the above table are the maximum tolerance of each flexible coupling.
- These values are based on standard roll grooved pipe. Figures for standard cut grooved pipe may increase.
- All the parameters in the above table are the maximum performance parameters. When designing and installing, the corresponding safety factor should be considered. It is suggested that the pipe diameter of DN25 ~ DN80 should be reduced to 50% and the pipe diameter of DN100 ~ DN300 should be reduced to 75%.

## Style 1GS Rigid Coupling

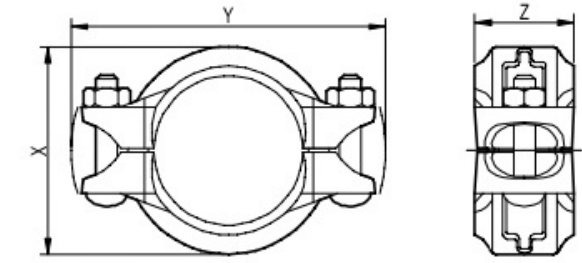

- Model 1GS rigid coupling, socketed & meshing design
- Female and male port socket design is not easy to make the horizontal and horizontal seal twists and turns, the gasket is not exposed, increasing the sealing and improve the overall service life of the joint
- Enhanced body resists 4 times working pressure.

Size		Max. Work Pressure	Max. End Load	Allow. Pipe End Sep.	Dimensions			Bolt/Nut Size	Approx. Wgt. Each
Nominal Dia.	Actual O.D.				X	Y	Z		
DN Inches	mm Inches	KPa PSI	N Lbs.	mm Inches	mm Inches	mm Inches	mm Inches	kg Lbs.	
25	33.4	5170	4530	2.3	54	98	44	M10X50	0.55
1	1.315	750	1020	0.091	2.126	3.858	1.732	3/8X2	1.21
32	42.4	5170	7300	2.3	63	109	44	M10X50	0.58
1 1/4	1.660	750	1620	0.091	2.480	4.291	1.732	3/8X2	1.28
40	48.3	5170	9470	2.3	69	115	44	M10X50	0.60
1 1/2	1.900	750	2130	0.091	2.717	4.528	1.732	3/8X2	1.32
50	60.3	4140	11820	2.3	83	128	45	M10X50	0.71
2	2.375	600	2660	0.091	3.268	5.039	1.772	3/8X2	1.56
65	73.0	3780	15820	2.3	97	142	46	M10X55	0.88
2 1/2	2.875	550	3570	0.091	3.819	5.591	1.811	3/8X2 1/4	1.94
65	76.1	3780	17190	2.3	100	145	46	M10X55	0.90
2 1/2	3.000	550	3890	0.091	3.937	5.709	1.811	3/8X2 1/4	1.98
80	88.9	3780	23460	2.7	113	159	47	M10X75	1.01
3	3.500	550	5290	0.106	4.449	6.260	1.850	3/8X2 1/4	2.22
100	108.0	3450	31610	2.7	136	192	49	M12X70	1.44
4	4.250	500	7090	0.106	5.354	7.559	1.929	1/2X2 1/4	3.17
100	114.3	3450	35400	2.7	142	198	49	M12X70	1.48
4	4.500	500	7950	0.106	5.591	7.795	1.929	1/2X2 1/4	3.26
125	133.0	3450	47930	2.7	163	224	50	M12X75	1.95
5	5.250	500	10820	0.106	6.417	8.819	1.969	1/2X3	4.30
125	139.7	3450	52880	2.7	169	230	50	M12X75	2.00
5	5.500	500	11880	0.106	6.654	9.055	1.969	1/2X3	4.41
125	141.3	3450	54100	2.7	171	232	50	M12X75	2.02
5	5.563	500	12150	0.106	6.732	9.134	1.969	1/2X3	4.45
150	159.0	3450	68500	2.7	190	249	51	M12X75	2.20
6	6.250	500	15340	0.106	7.480	9.803	2.008	1/2X3	4.85
150	165.1	3450	73860	2.7	196	254	51	M12X75	2.24
6	6.500	500	16590	0.106	7.717	10.000	2.008	1/2X3	4.93
150	168.3	3450	76750	2.7	199	257	51	M12X75	2.27
6	6.625	500	17240	0.106	7.835	10.118	2.008	1/2X3	5.00
200	219.1	2750	103680	4.9	256	328	58	M16X85	4.00
8	8.625	400	23370	0.193	10.079	12.913	2.283	3/8X3 1/8	8.81
250	273.0	2500	146340	4.9	311	397	59	M20X115	5.17
10	10.750	350	31770	0.193	12.244	15.630	2.323	3/4X4 1/2	11.39
300	323.9	2500	205990	4.9	365	451	60	M20X115	6.86
12	12.750	350	44690	0.193	14.370	17.756	2.362	3/4X4 1/2	15.11

- **Housing material** : Ductile iron conforming to ASTM A-536, grade 65-45-12.
- **FM Approved & UL Listed** : R.W.P. rated working pressure 300PSI(2.065MPa / 20.65bars)
- **Housing Finish** : Fusion Bonded Epoxy Coated ( Optional : Hot Deep Galvanized and Others )
- **Coupling gasket material** : EPDM ( Optional : Nitrile NBR , Silicone and Others )
- **Bolts and Nuts** : Heat treated and electro galvanized bolts with oval neck, and heavy duty hexagon nuts. Track head meeting the physical and chemical requirements of ASTM A-449 and physical requirements of ASTM A-183.
- **Size Range** : DN25 through DN300 (1" through 12")



## Grooved Couplings

## Grooved Couplings

### Style 1X Rigid Coupling – Angle pad

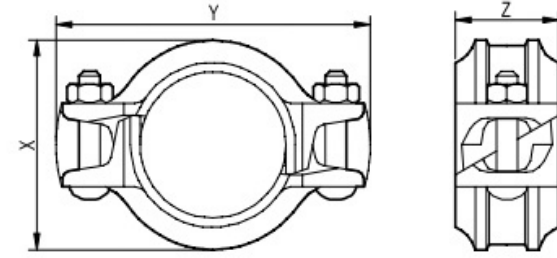

### Style 1N Flexible Coupling

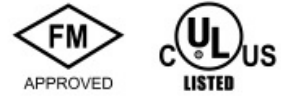
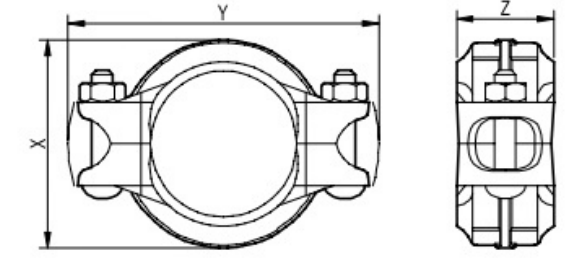

- Model 1X Angle pad rigid coupling
- This rigid coupling allows for more accurate positioning of the tube end, forming a fixed tube end separation, which should be considered in the design and installation.
- Enhanced body resists 4 times working pressure.

- Style 1N standard flexible coupling provides flexible connection by the gap between pipe groove and coupling key.
- Unique design allows both axial and radial movement, suitable for pipeline with flexibility under intermediate pressure.
- Enhanced body resists 4 times working pressure.

Size		Max. Work Pressure	Max. End Load	Allow. Pipe End Sep.	Dimensions			Bolt/Nut Size	Approx. Wgt. Each
Nominal Dia.	Actual O.D.				X	Y	Z		
DN	mm	KPa	N	mm	mm	mm	mm	kg	
Inches	Inches	PSI	Lbs.	Inches	Inches	Inches	Inches	Lbs.	
25	33.4	5170	4530	2.2	55	98	45	0.49	
1	1.315	750	1020	0.086	2.165	3.858	1.772	1.08	
32	42.4	5170	7300	2.2	64	110	45	0.58	
1 1/4	1.660	750	1620	0.086	2.520	4.331	1.772	1.28	
40	48.3	5170	9470	2.2	70	115	45	0.62	
1 1/2	1.900	750	2130	0.086	2.756	4.528	1.772	1.37	
50	60.3	4140	11820	2.2	85	130	47	0.77	
2	2.375	600	2660	0.086	3.346	5.118	1.850	1.70	
65	73.0	3780	15820	2.7	100	148	49	0.98	
2 1/2	2.875	550	3570	0.106	3.937	5.827	1.929	2.16	
65	76.1	3780	17190	2.7	103	151	49	1.00	
2 1/2	3.000	550	3890	0.106	4.055	5.945	1.929	2.20	
80	88.9	3780	23460	2.7	116	164	49	1.11	
3	3.500	550	5290	0.106	4.567	6.457	1.929	2.44	
100	108.0	3450	31610	3.3	138	188	51	1.48	
4	4.250	500	7090	0.130	5.433	7.402	2.008	3.26	
100	114.3	3450	35400	3.3	144	194	51	1.52	
4	4.500	500	7950	0.130	5.669	7.638	2.008	3.35	
125	133.0	3450	47930	3.3	165	226	51	2.07	
5	5.250	500	10820	0.130	6.496	8.898	2.008	4.56	
125	139.7	3450	52880	3.3	172	232	51	2.12	
5	5.500	500	11880	0.130	6.772	9.134	2.008	4.67	
125	141.3	3450	54100	3.3	173	234	51	2.14	
5	5.563	500	12150	0.130	6.811	9.213	2.008	4.71	
150	159.0	3450	68500	3.3	192	252	52	2.42	
6	6.250	500	15340	0.130	7.559	9.921	2.047	5.33	
150	165.1	3450	73860	3.3	198	258	52	2.48	
6	6.500	500	16590	0.130	7.795	10.157	2.047	5.46	
150	168.3	3450	76750	3.3	201	261	52	2.53	
6	6.625	500	17240	0.130	7.913	10.276	2.047	5.57	
200	219.1	2750	103680	4.9	260	325	61	4.49	
8	8.625	400	23370	0.193	10.236	12.795	2.402	9.89	
250	273.0	2500	146340	4.9	314	397	61	5.53	
10	10.750	350	31770	0.193	12.362	15.630	2.402	12.18	
300	323.9	2500	205990	4.9	368	451	62	7.22	
12	12.750	350	44690	0.193	14.488	17.756	2.441	15.90	

Size		Max. Work Pressure	Max. End Load	Allow. Pipe End Sep.	Dimensions			Bolt/Nut Size	Approx. Wgt. Each
Nominal Dia.	Actual O.D.				X	Y	Z		
DN	mm	KPa	N	mm	mm	mm	mm	kg	
Inches	Inches	PSI	Lbs.	Inches	Inches	Inches	Inches	Lbs.	
25	33.4	5170	4530	2.2	53	98	44	0.55	
1	1.315	750	1020	0.087	2.087	3.858	1.732	1.21	
32	42.4	5170	7300	2.2	62	110	44	0.58	
1 1/4	1.660	750	1620	0.087	2.441	4.331	1.732	1.28	
40	48.3	5170	9470	2.2	68	115	44	0.60	
1 1/2	1.900	750	2130	0.087	2.677	4.528	1.732	1.32	
50	60.3	4140	11820	2.2	83	130	45	0.71	
2	2.375	600	2660	0.087	3.268	5.118	1.772	1.56	
65	73.0	3780	15820	2.4	97	144	46	0.90	
2 1/2	2.875	550	3570	0.094	3.819	5.669	1.811	1.98	
65	76.1	3780	17190	2.4	100	147	46	1.00	
2 1/2	3.000	550	3890	0.094	3.937	5.787	1.811	2.20	
80	88.9	3780	23460	2.8	113	172	47	1.11	
3	3.500	550	5290	0.110	4.449	6.772	1.850	2.44	
100	108.0	3450	31610	3.3	136	196	51	1.62	
4	4.250	500	7090	0.130	5.354	7.717	2.008	3.57	
100	114.3	3450	35400	3.3	142	202	51	1.66	
4	4.500	500	7950	0.130	5.591	7.953	2.008	3.66	
125	133.0	3450	47930	3.6	166	230	51	2.37	
5	5.250	500	10820	0.142	6.535	9.055	2.008	5.22	
125	139.7	3450	52880	3.6	172	236	51	2.42	
5	5.500	500	11880	0.142	6.772	9.291	2.008	5.33	
125	141.3	3450	54100	3.6	174	238	51	2.44	
5	5.563	500	12150	0.142	6.850	9.370	2.008	5.37	
150	159.0	3450	68500	3.9	190	266	52	2.72	
6	6.250	500	15340	0.154	7.480	10.472	2.047	5.99	
150	165.1	3450	73860	3.9	196	272	52	2.78	
6	6.500	500	16590	0.154	7.717	10.709	2.047	6.12	
150	168.3	3450	76750	3.9	199	275	52	2.83	
6	6.625	500	17240	0.154	7.835	10.827	2.047	6.23	
200	219.1	2750	103680	4.9	256	343	61	5.06	
8	8.625	400	23370	0.193	10.079	13.504	2.402	11.15	
250	273.0	2500	146340	4.9	311	397	61	5.91	
10	10.750	350	31770	0.193	12.244	15.630	2.402	13.02	
300	323.9	2500	205990	4.9	365	451	62	7.39	
12	12.750	350	44690	0.193	14.370	17.756	2.441	16.28	

- **Housing material** : Ductile iron conforming to ASTM A-536, grade 65-45-12.
- **FM Approved & UL Listed** : R.W.P. rated working pressure 300PSI(2.065MPa / 20.65bars)
- **Housing Finish** : Fusion Bonded Epoxy Coated ( Optional : Hot Deep Galvanized and Others )
- **Coupling gasket material** : EPDM ( Optional : Nitrile NBR , Silicone and Others )
- **Bolts and Nuts** : Heat treated and electro galvanized bolts with oval neck, and heavy duty hexagon nuts. Track head meeting the physical and chemical requirements of ASTM A-449 and physical requirements of ASTM A-183.
- **Size Range** : DN25 through DN300 (1" through 12")

- **Housing material** : Ductile iron conforming to ASTM A-536, grade 65-45-12.
- **FM Approved & UL Listed** : R.W.P. rated working pressure 300PSI(2.065MPa / 20.65bars)
- **Housing Finish** : Fusion Bonded Epoxy Coated ( Optional : Hot Deep Galvanized and Others )
- **Coupling gasket material** : EPDM ( Optional : Nitrile NBR , Silicone and Others )
- **Bolts and Nuts** : Heat treated and electro galvanized bolts with oval neck, and heavy duty hexagon nuts. Track head meeting the physical and chemical requirements of ASTM A-449 and physical requirements of ASTM A-183.
- **Size Range** : DN25 through DN300 (1" through 12")



## Grooved Couplings

### Style 1NH Heavy Duty Flexible Coupling

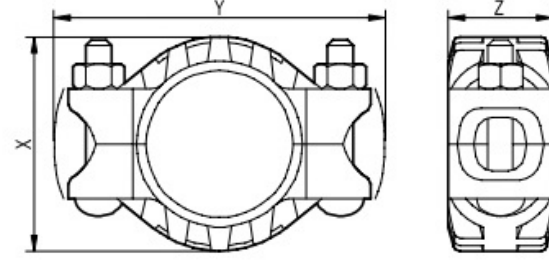

- Style 1NH heavy duty flexible coupling provides flexible connection by the gap between pipe groove and coupling key.
- Unique design allows both axial and radial movement, suitable for pipeline with flexibility under intermediate pressure.
- Enhanced body resists 4 times working pressure.

Size		Max. Work Pressure	Max. End Load	Allow. Pipe End Sep.	Dimensions			Bolt/Nut Size	Approx. Wgt. Each
Nominal Dia.	Actual O.D.				X	Y	Z		
DN	mm	KPa	N	mm	mm	mm	mm	kg	
Inches	Inches	PSI	Lbs.	Inches	Inches	Inches	Inches	Lbs.	
25	33.4	10350	9068	2.2	57	101	44	M10X50	0.73
1	1.315	1500	2037	0.087	2.244	3.976	1.732	3/8X2 1/4	1.61
32	42.4	860	1214	2.2	66	113	45	M12X60	0.91
1 1/4	1.660	1250	2705	0.087	2.598	4.449	1.772	1/2X2 1/8	2.00
40	48.3	860	1576	2.2	72	121	45	M12X60	0.97
1 1/2	1.900	1250	3544	0.087	2.835	4.764	1.772	1/2X2 1/8	2.14
50	60.3	860	2456	2.2	87	138	47	M12X60	1.20
2	2.375	1250	5538	0.087	3.425	5.433	1.850	1/2X2 1/8	2.64
65	73.0	6900	28879	2.4	101	152	49	M12X75	1.52
2 1/2	2.875	1000	6492	0.094	3.976	5.984	1.929	1/2X3	3.35
65	76.1	6900	31384	2.4	104	155	49	M12X75	1.54
2 1/2	3.000	1000	7069	0.094	4.094	6.102	1.929	1/2X3	3.39
80	88.9	6900	42830	2.8	118	170	49	M12X75	1.71
3	3.500	1000	9621	0.110	4.646	6.693	1.929	1/2X3	3.77
100	108.0	6900	63210	3.3	142	206	51	M16X85	2.60
4	4.250	1000	14186	0.130	5.591	8.110	2.008	3/8X3 1/8	5.73
100	114.3	6900	70800	3.3	148	212	51	M16X85	2.67
4	4.500	1000	15904	0.130	5.827	8.346	2.008	3/8X3 1/8	5.88
125	133.0	6900	95861	3.6	169	243	51	M20X115	3.58
5	5.250	1000	21648	0.142	6.654	9.567	2.008	1/2X4 1/2	7.89
125	139.7	6900	105763	3.6	176	249	51	M20X115	3.65
5	5.500	1000	23758	0.142	6.929	9.803	2.008	1/2X4 1/2	8.04
125	141.3	6900	108199	3.6	177	251	51	M20X115	3.67
5	5.563	1000	24306	0.142	6.969	9.882	2.008	1/2X4 1/2	8.08
150	159.0	6900	137004	3.9	197	271	51	M20X115	4.05
6	6.250	1000	30680	0.154	7.756	10.669	2.008	1/2X4 1/2	8.92
150	165.1	6900	147718	3.9	203	277	51	M20X115	4.13
6	6.500	1000	33183	0.154	7.992	10.906	2.008	1/2X4 1/2	9.10
150	168.3	6900	153500	3.9	206	279	51	M20X115	4.15
6	6.625	1000	34472	0.154	8.110	10.984	2.008	1/2X4 1/2	9.14
200	219.1	5500	207366	4.9	267	357	63	M22X135	8.35
8	8.625	800	46741	0.193	10.512	14.055	2.480	7/8X5 1/2	18.39
250	273.0	5500	321943	4.9	320	410	65	M24X135	10.70
10	10.750	800	72610	0.193	12.598	16.142	2.559	1X5 1/2	23.57
300	323.9	5500	453185	4.9	370	460	65	M24X135	12.30
12	12.750	800	102141	0.193	14.567	18.110	2.559	1X5 1/2	27.09

- **Housing material** : Ductile iron conforming to ASTM A-536, grade 65-45-12.
- **FM Approved & UL Listed** : R.W.P. rated working pressure 300PSI(2.065MPa / 20.65bars)
- **Housing Finish** : Fusion Bonded Epoxy Coated ( Optional : Hot Deep Galvanized and Others )
- **Coupling gasket material** : EPDM ( Optional : Nitrile NBR , Silicone and Others )
- **Bolts and Nuts** : Heat treated and electro galvanized bolts with oval neck, and heavy duty hexagon nuts. Track head meeting the physical and chemical requirements of ASTM A-449 and physical requirements of ASTM A-183.
- **Size Range** : DN25 through DN300 (1" through 12")

## Grooved Couplings

### Style 1NR Reducing Flexible Coupling

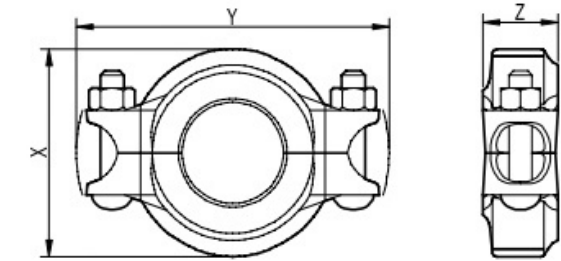

- Model 1NR is a reducing flexible coupling. Two ends can connect to different diameter of steel pipe. The middle of the coupling with a steel plate to avoid telescope by vertical installation.
- The structure ensures lower cost and faster installation under the premise of ensuring the strength.
- Enhanced body resists 4 times working pressure.

Size		Max. Work Pressure	Max. End Load	Allow. Pipe End Sep.	Dimensions			Bolt/Nut Size	Approx. Wgt. Each
Run Pipe	Branch Pipe				X	Y	Z		
mm	X mm	KPa	N	mm	mm	mm	mm	kg	
Inches	X Inches	PSI	Lbs.	Inches	Inches	Inches	Inches	Lbs.	
48.3	X 42.4	3800	5365	2.4	64	129	47	M10X50	0.66
1 1/2	1 1/4	550	1190	0.094	2.520	5.079	1.850	3/8X2	1.45
60.3	X 42.4	3800	5365	2.6	80	145	47	M10X50	0.86
2	1 1/4	550	1190	0.102	3.150	5.709	1.850	3/8X2	1.89
	48.3	3800	6963	2.6	80	145	47	M10X50	0.87
	1 1/2	550	1559	0.102	3.150	5.709	1.850	3/8X2	1.92
73.0	X 60.3	3800	10852	2.9	95	160	49	M12X75	1.31
2 1/2	2	550	2437	0.114	3.740	6.299	1.929	1/2X3	2.89
76.1	60.3	3800	10852	2.9	98	164	49	M12X75	1.35
2 1/2	2	550	2437	0.114	3.858	6.457	1.929	1/2X3	2.97
88.9	X 60.3	3450	9852	3.1	115	178	49	M12X75	1.59
3	2	500	2215	0.122	4.528	7.008	1.929	1/2X3	3.50
	73.0	3800	15905	3.1	115	178	49	M12X75	1.54
	2 1/2	550	3571	0.122	4.528	7.008	1.929	1/2X3	3.39
	76.1	3800	17284	3.1	115	178	49	M12X75	1.48
	2 1/2	550	3888	0.122	4.528	7.008	1.929	1/2X3	3.26
114.3	X 60.3	3450	9852	3.5	141	208	51	M16X85	2.72
4	2	500	2215	0.138	5.551	8.189	2.008	3/8X3 1/8	5.99
	73.0	3450	14440	3.5	141	208	51	M16X85	2.55
	2 1/2	500	3246	0.138	5.551	8.189	2.008	3/8X3 1/8	5.62
	76.1	3450	15692	3.5	141	208	51	M16X85	2.51
	2 1/2	500	3534	0.138	5.551	8.189	2.008	3/8X3 1/8	5.53
	88.9	3800	23587	3.5	141	208	51	M16X85	2.33
	3	550	5292	0.138	5.551	8.189	2.008	3/8X3 1/8	5.13
139.7	X 88.9	2750	17070	4.0	168	247	51	M20X115	3.68
5	3	400	3848	0.157	6.614	9.724	2.008	1/2X4 1/2	8.11
	114.3	3100	31809	4.0	168	247	51	M20X115	3.19
	4	450	7157	0.157	6.614	9.724	2.008	1/2X4 1/2	7.03
141.3	X 88.9	2750	17070	4.0	169	249	51	M20X115	3.74
5	3	400	3848	0.157	6.654	9.803	2.008	1/2X4 1/2	8.24
	114.3	3100	31809	4.0	169	249	51	M20X115	3.45
	4	450	7157	0.157	6.654	9.803	2.008	1/2X4 1/2	7.60
165.1	X 114.3	2750	28217	4.7	197	276	51	M20X115	4.25
6	4	400	6362	0.185	7.756	10.866	2.008	1/2X4 1/2	9.36
	139.7	3100	47517	4.7	197	276	51	M20X115	3.68
	5	450	10691	0.185	7.756	10.866	2.008	1/2X4 1/2	8.11
168.3	X 114.3	2750	28217	4.7	199	276	51	M20X115	4.24
	4	400	6362	0.185	7.835	10.866	2.008	1/2X4 1/2	9.34
	114.3	3100	48611	4.7	199	276	51	M20X115	3.82
	5	450	10938	0.185	7.835	10.866	2.008	1/2X4 1/2	8.41
219.1	X 165.1	2750	58873	4.9	261	356	61	M22X135	8.45
8	6	400	13273	0.193	10.276	14.016	2.402	7/8X5 1/2	18.61
	168.3	2750	61178	4.9	261	356	61	M22X135	8.38
	6	400	13789	0.193	10.276	14.016	2.402	7/8X5 1/2	18.46

- **Housing material** : Ductile iron conforming to ASTM A-536, grade 65-45-12.
- **FM Approved & UL Listed** : R.W.P. rated working pressure 300PSI(2.065MPa / 20.65bars)
- **Housing Finish** : Fusion Bonded Epoxy Coated ( Optional : Hot Deep Galvanized and Others )
- **Coupling gasket material** : EPDM ( Optional : Nitrile NBR , Silicone and Others )
- **Bolts and Nuts** : Heat treated and electro galvanized bolts with oval neck, and heavy duty hexagon nuts. Track head meeting the physical and chemical requirements of ASTM A-449 and physical requirements of ASTM A-183.
- **Size Range** : DN40 X DN32 through DN150 (1 1/2" X 1 1/4" through 8"X6")



## Grooved Couplings

### Style 321 Split Flange

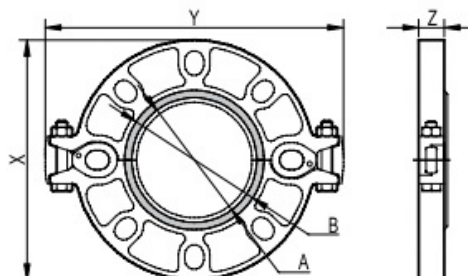

- Style 321 split flange mainly use for the flange connection with the valve, equipment or pipe conversion connection to solve the groove connection and flange connection conversion, installation is simple and fast.
- Model 321 split flange's bolt holes designed into oval hole. ANSI Class 125 & 150 and PN16 grade flanges are universally available, with DN50 to DN80 (2" to 3" ) for both PN10 and PN25 nominal flanges; DN100 to DN150 (4" to 6" ) for both flanges PN10 nominal grade flange.
- In addition to the standard flanges described above, it is also available to provide flanges under other standards such as JIS 10K and ANSI Class 300.

Size		Max. Work Pressure	Max. End Load	Gasket Seat		Dimensions			Bolt/Nut Size	Approx. Wgt. Each
Nominal Dia.	Actual O.D.			A	B	X	Y	Z		
DN Inches	mm Inches	KPa PSI	N Lbs.	mm Inches	mm Inches	mm Inches	mm Inches	mm Inches	mm Inches	kg Lbs.
50	60.3	3450	9852	64	78	165	218	20	M10X70	1.76
2	2.375	500	2215	2.520	3.071	6.496	8.583	0.787	3/8x2 1/4	3.87
65	73.0	3450	14440	77	91	178	228	22	M10X70	2.04
2 1/2	2.875	500	3246	3.031	3.583	7.008	8.976	0.866	3/8x2 1/4	4.50
65	76.1	3450	15692	80	94	185	238	22	M10X70	2.41
2 1/2	3.000	500	3534	3.150	3.701	7.283	9.370	0.866	3/8x2 1/4	5.30
80	88.9	3450	21415	93	107	200	250	22	M10X70	2.55
3	3.500	500	4811	3.661	4.213	7.874	9.843	0.866	3/8x2 1/4	5.62
100	114.3	3450	35400	119	133	229	280	24	M10X70	3.24
4	4.500	500	7952	4.685	5.236	9.016	11.02	0.945	3/8x2 1/4	7.14
125	139.7	3450	52881	145	159	250	313	22	M12X70	3.49
5	5.500	500	11879	5.709	6.260	9.843	12.32	0.866	1/2x2 1/4	7.68
125	141.3	3450	54100	146	160	254	321	26	M12X70	4.39
5	5.563	500	12153	5.748	6.299	10.00	12.64	1.024	1/2x2 1/4	9.67
150	165.1	3450	73859	171	185	285	347	24	M12X70	4.55
6	6.500	500	16592	6.732	7.283	11.22	13.66	0.945	1/2x2 1/4	10.02
150	168.3	3450	76750	174	188	285	345	26	M12X70	4.73
6	6.625	500	17236	6.850	7.402	11.22	13.58	1.024	1/2x2 1/4	10.42
200	219.1	2750	103683	225	242	343	404	30	M12X70	6.95
8	8.625	400	23371	8.858	9.528	13.50	15.91	1.181	1/2x2 1/4	15.31

- **Housing material** : Ductile iron conforming to ASTM A-536, grade 65-45-12.
- **FM Approved & UL Listed** : R.W.P. rated working pressure 300PSI(2.065MPa / 20.65bars)
- **Housing Finish** : Fusion Bonded Epoxy Coated ( Optional : Hot Deep Galvanized and Others )
- **Coupling gasket material** : EPDM ( Optional : Nitrile NBR , Silicone and Others )
- **Bolts and Nuts** : Heat treated and electro galvanized bolts with oval neck, and heavy duty hexagon nuts. Track head meeting the physical and chemical requirements of ASTM A-449 and physical requirements of ASTM A-183.
- **Size Range** : DN50 through DN200 (2" through 8")

## Grooved Couplings

### Style FW Flange Steel Plate

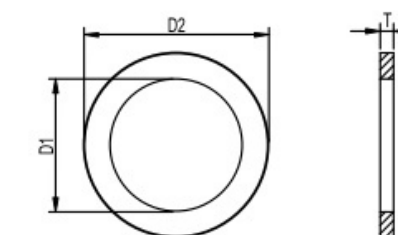

- Suitable for all variety of style 321 split flanges.
- Hot -dip galvanized surface
- Size : DN50~DN200  
2" ~ 8"

Size		Dimensions			Approx. Wgt. Each
Nominal Dia.	Actual O.D.	D1	D2	T	
DN Inches	mm Inches	mm Inches	mm Inches	mm Inches	kg Lbs.
50	60.3	60	99	3	0.11
2	2.375	2.362	3.898	0.118	0.25
65	73.0	73	118	3	0.16
2 1/2	2.875	2.874	4.646	0.118	0.35
65	76.1	76	118	3	0.15
2 1/2	3.000	2.992	4.646	0.118	0.33
80	88.9	89	132	3	0.17
3	3.500	3.504	5.197	0.118	0.38
100	108.0	108	156	4	0.31
4	4.250	4.252	6.142	0.157	0.68
100	114.3	114	156	4	0.28
4	4.500	4.488	6.142	0.157	0.61
125	133.0	133	184	5	0.49
5	5.250	5.236	7.244	0.197	1.09
125	139.7	140	184	5	0.44
5	5.500	5.512	7.244	0.197	0.96
125	141.3	140	184	5	0.44
5	5.563	5.512	7.244	0.197	0.96
150	159.0	159	211	5	0.59
6	6.250	6.260	8.307	0.197	1.30
150	165.1	165	211	5	0.53
6	6.500	6.496	8.307	0.197	1.17
150	168.3	168	211	5	0.50
6	6.625	6.614	8.307	0.197	1.10
200	219.1	219	273	6	0.98
8	8.625	8.622	10.748	0.236	2.15

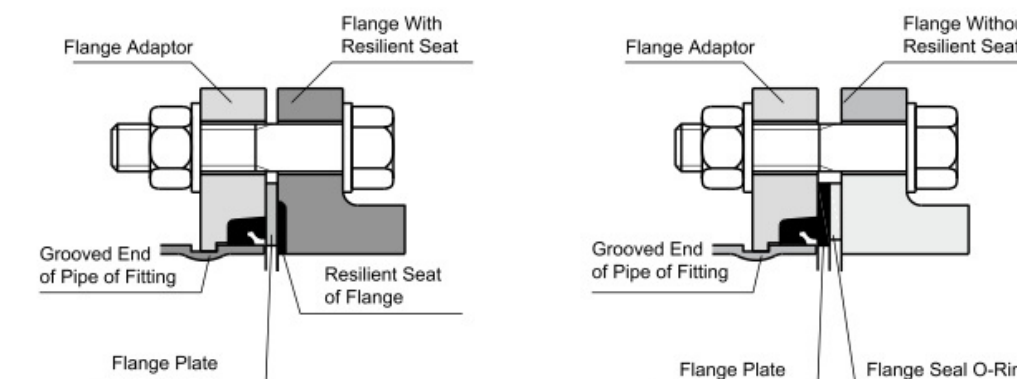

- Model 321 split flange assembled on a flange with a soft sealing surface, a steel plate will be added in the middle.
- Model 321 split flanges are connected with the flange without soft sealing surface, the middle of the flange should be attached metal flange gasket and rubber flange.



## General



Grooved pipe fittings mainly include groove elbows, tee, cross, head, end cap and flange adaptor, etc., is an indispensable accessory in the grooved piping system, widely used in the whole system. Due to the grooved pipe fittings, making the site on-site installation and piping becomes quick and easy, is a very ideal way of piping.

The commonly used grooved fittings are made by the casting process. Most of the groove parts are made by casting. The advanced equipment and exquisite casting technology ensure the dimension accuracy of the groove. Machined grooves used, high precision machining, to ensure the reliability of the pipe system connection.

The material of the grooved pipe fitting is ductile iron, which has the same performance as the connector shell. It has very high strength and toughness, and is a high-quality and long-life product.

The power of the pipeline system is provided by the pump. After passing through the entire piping system, it is ensured that sufficient pressure will be obtained on reaching the water equipment or appliances, and the pressure loss of the piping system will be minimized and the energy saving effect of the system will also be achieved.

The pressure loss of the pipe system is mainly caused by the pressure loss of pipes, pipe fittings, valves and some other fittings or accessories. The most serious pressure loss is the fittings of the pipe fittings. Therefore, it is very necessary to effectively control and improve the pressure loss of pipe fittings.

CNG groove fittings have carried out the calculation of the flow coefficient, to ensure product safety and life expectancy, but also to ensure adequate flow path diameter, turning radius and the smoothness of the inner surface, so as to ensure The pressure loss of the entire pipeline system is reduced, and the energy saving effect is achieved.

The pressure loss of CNG grooved pipe fittings can be estimated by referring to the flow coefficient table on the next page..

CNG groove fittings in addition to the standard ductile iron parts, there are other types of pipe fittings.

- lined plastic grooved pipe fittings
- The lining plastic is lined with a layer of PTFE material on the inner surface of the pipe fitting, which is tasteless and non-toxic, and is an environmentally friendly food-grade material. Plastic pipe fittings are mainly used in domestic water piping systems or food-grade requirements of the pipeline system, such as pharmaceutical, food and other industries process pipeline.
- hot galvanized groove pipe fittings
- Steel grooved pipe fittings

## Flow Date

The chart expresses the frictional resistance of various CNG fittings as equivalent feet of straight pipe. Fittings not listed can be estimated from the data given, for example, a 22.5° elbow is approximately one-half the resistance of a 45° elbow. Values of mid-sizes can be interpolated.

Size		90° Elbow		45° Elbow		Tee		Size		90° Elbow		45° Elbow		Tee	
Nominal Dia.	Actual O.D.	Style 90	Style 9015D	Style 120	Style 9015D	Branch	RUN	Nominal Dia.	Actual O.D.	Style 90	Style 9015D	Style 120	Style 9015D	Branch	RUN
DN	mm	m	m	m	m	m	m	DN	mm	m	m	m	m	m	m
Inches	Inches	Feet	Feet	Feet	Feet	Feet	Feet	Inches	Inches	Feet	Feet	Feet	Feet	Feet	Feet
25	33.4	0.5	—	0.2	—	1.3	0.5	125	133.0	2.5	1.9	1.2	0.8	6.2	2.5
1	1.315	1.6	—	0.7	—	4.3	1.6	5	5.250	8.2	6.2	3.9	2.6	20.3	8.2
32	424.	0.8	—	0.4	—	1.8	0.8	125	139.7	2.6	2.0	1.3	0.8	6.4	2.6
1 1/4	1.660	2.6	—	1.3	—	5.9	2.6	5	5.500	8.5	6.6	4.3	2.6	21.0	8.5
40	48.3	0.9	—	0.4	—	2.0	0.9	125	141.3	2.6	2.0	1.3	0.8	6.4	2.6
1 1/2	1.900	3.0	—	1.3	—	6.6	3.0	5	5.563	8.5	6.6	4.3	2.6	21.0	8.5
50	60.3	1.1	0.8	0.5	0.3	2.6	1.1	150	159.0	2.9	2.2	1.5	0.9	7.6	2.9
2	2.375	3.6	2.6	1.6	1.0	8.5	3.6	6	6.250	9.5	7.2	4.9	3.0	24.9	9.5
65	73.0	1.2	0.9	0.6	0.4	3.2	1.2	150	165.1	2.9	2.3	1.5	0.9	7.6	3.0
2 1/2	2.875	3.9	3.0	2.0	1.3	10.5	3.9	6	6.500	9.5	7.2	4.9	3.0	24.9	9.5
65	76.1	1.3	1.0	0.7	0.4	3.3	1.3	150	168.3	3.0	2.3	1.5	0.9	7.6	3.0
2 1/2	3.000	4.3	3.3	2.3	1.3	10.8	4.3	6	6.625	9.8	7.5	4.9	3.0	24.9	9.8
80	88.9	1.5	1.2	0.8	0.5	4.0	1.5	200	219.1	4.0	3.0	2.0	1.2	10.1	4.0
3	3.500	4.9	3.9	2.6	1.6	13.1	4.9	8	8.625	13.1	9.8	6.6	3.9	33.1	13.1
100	108.0	2.0	1.4	0.9	0.6	4.7	2.0	250	273.0	5.2	3.7	2.5	1.5	12.5	5.2
4	4.250	6.6	4.6	3.0	2.0	15.4	6.6	10	10.750	17.1	12.1	8.2	4.9	41.0	17.1
100	114.3	2.1	1.5	1.0	0.6	4.9	2.1	300	323.9	6.1	4.4	3.0	1.8	15.2	6.1
4	4.500	6.9	4.9	3.3	2.0	16.1	6.9	12	12.750	20.0	14.4	9.8	5.9	49.9	20.0

Note: The flow data listed is based upon the pressure drop of Schedule 40 pipe.

## Material Specifications

### Housing :

A : Ductile cast iron, QT450-12.conforming to ASTM A—536 , Grade 65—45—12.

Ductile cast iron material is not easy to rust, high strength & toughness, good extensibility, but also has strong shock absorption properties.

B : Steel, steel groove pipe fittings made of high-quality cold-rolled steel pipe, the groove is made of rolled (also according to customer requirements for cutting groove ) ,

### Housing color:

Standard color: orange red paint











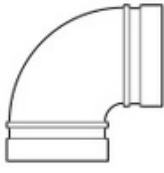
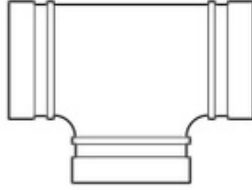
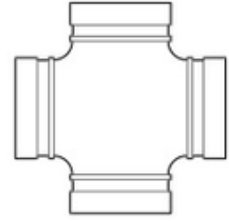
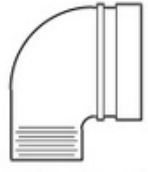
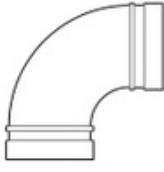
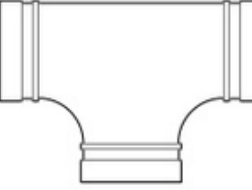
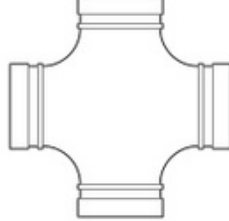

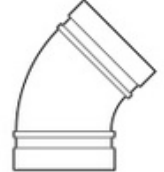
Electrostatic powder epoxy resin powder, salt spray time more than 600 hours, superior corrosion resistance.

**Other Optional:** blue paint, gray paint, galvanized, etc. (order must be specified)







## Grooved Fittings

- The rated pressure of all standard pipe fittings is equal to the rated pressure of the coupling is used
- All pipe fittings are cut groove ends, as well as thread, flange and other conversion ends.
- Housing Finish: Fusion Bonded Epoxy Coated(Optional:Hot Deep Galvanized and Others)

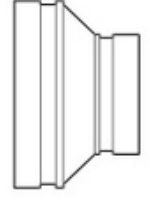
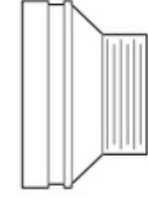
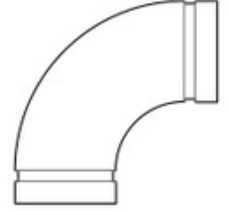
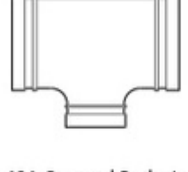
 <p>Style 90S 90° Short Elbow DN50~DN200 2"~8" 60.3mm~219.1mm</p> <p>FM APPROVED UL LISTED</p>	 <p>Style 130S Short Equal Tee DN50~DN200 2"~8" 60.3mm~219.1mm</p> <p>FM APPROVED UL LISTED</p>	 <p>Style 180S Short Equal Cross DN50~DN200 2"~8" 60.3mm~219.1mm</p> <p>FM APPROVED UL LISTED</p>	 <p>Style 90RT 90° Reducing Elbow GxT DN25~DN65 1 1/4"~2 1/2" 42.4mm~76.1mm</p> <p>FM APPROVED UL LISTED</p>
 <p>Style 90 90° Std. Elbow DN25~DN300 1"~12" 33.4mm~323.9mm</p> <p>FM APPROVED UL LISTED</p>	 <p>Style 130 Std. Equal Tee DN25~DN300 1"~12" 33.4mm~323.9mm</p> <p>FM APPROVED UL LISTED</p>	 <p>Style 180 Std. Equal Cross DN25~DN300 1"~12" 33.4mm~323.9mm</p> <p>FM APPROVED UL LISTED</p>	 <p>Style 90DE 90° Drain Elbow DN50~DN200 2"~8" 60.3mm~219.1mm</p> <p>FM APPROVED UL LISTED</p>
 <p>Style 120 45° Elbow DN25~DN300 1"~12" 33.4mm~323.9mm</p> <p>FM APPROVED UL LISTED</p>	 <p>Style 110 22.5° Elbow DN25~DN300 1"~12" 33.4mm~323.9mm</p> <p>FM APPROVED UL LISTED</p>	 <p>Style 105 11.25° Elbow DN25~DN300 1"~12" 33.4mm~323.9mm</p> <p>FM APPROVED UL LISTED</p>	 <p>Style 321G Flange Adaptor Nipple DN50~DN300 2"~12" 60.3mm~323.9mm</p> <p>FM APPROVED UL LISTED</p>
 <p>Style 300 End Cap DN25~DN300 1"~12" 33.4mm~323.9mm</p> <p>FM APPROVED UL LISTED</p>	 <p>Style 300CH End Cap With Center Hole DN50~DN300 2"~12" 60.3mm~323.9mm</p> <p>FM APPROVED UL LISTED</p>	 <p>Style 300EH End Cap With Eccentric Hole DN50~DN300 2"~12" 60.3mm~323.9mm</p> <p>FM APPROVED UL LISTED</p>	 <p>Style 018GG Grooved X Grooved Nipple DN25~DN300 1"~12" 33.4mm~323.9mm</p> <p>FM APPROVED UL LISTED</p>
			 <p>Style 018GT Grooved X Threaded Nipple DN25~DN300 1"~12" 33.4mm~323.9mm</p> <p>FM APPROVED UL LISTED</p>
			 <p>Style 018GB Grooved X Bevel Nipple DN25~DN300 1"~12" 33.4mm~323.9mm</p> <p>FM APPROVED UL LISTED</p>

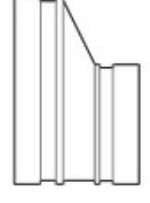
## Grooved Fittings

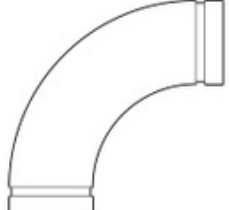
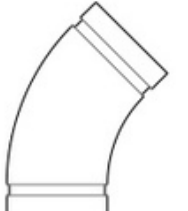
 <p>Style 240 Grooved Concentric Reducer DN32X25~DN300X250 1 1/2"X1"~12X10" 42.4X33.4mm~323.9X273.0mm</p> <p>FM APPROVED UL LISTED</p>	 <p>Style 240N Threaded Concentric Reducer DN32X15~DN300X80 1 1/2"X1/2"~12X3" 42.4X21.3mm~323.9X88.9mm</p> <p>FM APPROVED UL LISTED</p>	 <p>Style 9015D Long Radius 90° Elbows 1.5 D DN50~DN300 2"~12" 60.3mm~323.9mm</p>
 <p>Style 131 Grooved Reducing Tee DN32X25~DN300X250 1 1/2"X1"~12X10" 42.4X33.4mm~323.9X273.0mm</p> <p>FM APPROVED UL LISTED</p>	 <p>Style 131N Threaded Reducing Tee DN32X15~DN300X80 1 1/2"X1/2"~12X3" 42.4X21.3mm~323.9X88.9mm</p> <p>FM APPROVED UL LISTED</p>	 <p>Style 4515D Long Radius 45° Elbows 1.5 D DN50~DN300 2"~12" 60.3mm~323.9mm</p>
 <p>Style 230 Grooved Eccentric Reducer DN32X25~DN300X250 1 1/2"X1"~12X10" 42.4X33.4mm~323.9X273.0mm</p> <p>FM APPROVED UL LISTED</p>	 <p>Style 230N Threaded Eccentric Reducer DN32X15~DN300X80 1 1/2"X1/2"~12X3" 42.4X21.3mm~323.9X88.9mm</p> <p>FM APPROVED UL LISTED</p>	 <p>Style 9030D Long Radius 90° Elbows 3D DN50~DN300 2"~12" 60.3mm~323.9mm</p>
		 <p>Style 4530D Long Radius 45° Elbows 3D DN50~DN300 2"~12" 60.3mm~323.9mm</p>

## 90° Short Elbow, Short Equal Tee & Short Equal Cross

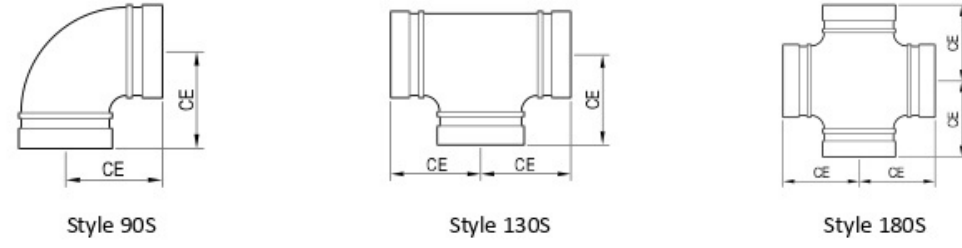

### Style 90S 90° Short Elbow



### Style 130S Short Equal Tee



### Style 180S Short Equal Cross

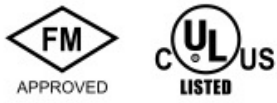

Size		Style 90S 90° Short Elbow		Style 130S Short Equal Tee		Style 180S Short Equal Cross	
Nominal Dia.	Actual O.D.	CE	Approx. Wgt.	CE	Approx. Wgt.	CE	Approx. Wgt.
Inches	Inches	Inches	Lbs.	Inches	Lbs.	Inches	Lbs.
50	60.3	70	0.6	70	0.9	70	1.1
2	2.375	2.75	1.32	2.75	1.98	2.75	2.42
65	73.0	76	0.8	76	1.2	76	1.5
2½	2.875	3.00	1.76	3.00	2.64	3.00	3.30
65	76.1	76	1.0	76	1.4	76	1.8
2½	3.000	3.00	2.20	3.00	3.08	3.00	3.96
80	88.9	86	1.3	86	1.7	86	2.3
3	3.500	3.40	2.86	3.40	3.74	3.40	5.07
100	108.0	102	2.0	102	2.6	102	3.3
4	4.250	4.00	4.41	4.00	5.73	4.00	7.27
100	114.3	102	2.1	102	2.8	102	3.6
4	4.500	4.00	4.63	4.00	6.17	4.00	7.93
125	133.0	124	3.4	124	4.3	124	5.8
5	5.250	4.88	7.49	4.88	9.47	4.88	12.78
125	139.7	124	3.5	124	4.4	124	6.0
5	5.500	4.88	7.71	4.88	9.69	4.88	13.22
125	141.3	124	3.6	124	4.5	124	6.1
5	5.563	4.88	7.93	4.88	9.91	4.88	13.44
150	159.0	140	5.2	140	6.7	140	8.7
6	6.250	5.50	11.45	5.50	14.76	5.50	19.16
150	165.1	140	5.4	140	7.0	140	9.0
6	6.500	5.50	11.89	5.50	15.42	5.50	19.82
150	168.3	140	5.6	140	7.2	140	9.2
6	6.625	5.50	12.33	5.50	15.86	5.50	20.26
200	219.1	173	10.5	173	14.0	173	16.5
8	8.625	6.80	23.13	6.80	30.84	6.80	36.34

- **Housing material:** Ductile iron conforming to ASTM A-536, grade 65-45-12.
- **FM Approved & UL Listed:** R.W.P. rated working pressure 300PSI (2.065MPa / 20.65bars)
- **Housing Finish:** Fusion Bonded Epoxy Coated (Optional: Hot Deep Galvanized and Others)
- **Size Range:** DN50 through DN200 (2" through 8")

## 90° Standard Elbow, Standard Equal Tee & Standard Equal Cross

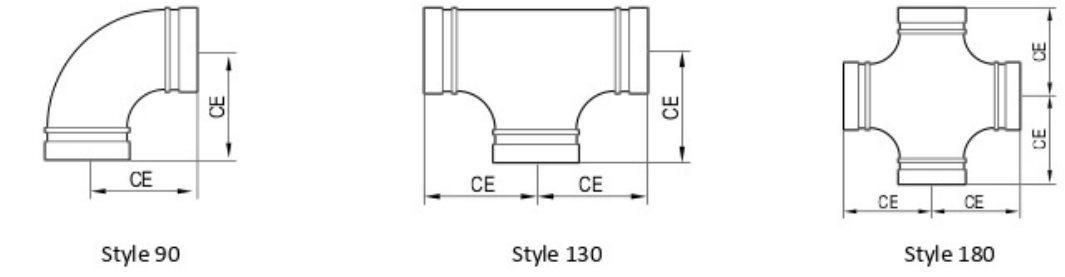

### Style 90 90° Standard Elbow



### Style 130 Standard Equal Tee



### Style 180 Standard Equal Cross



Size		Style 90 90° Std. Elbow		Style 130 Std. Equal Tee		Style 180 Std. Equal Cross	
Nominal Dia.	Actual O.D.	CE	Approx. Wgt.	CE	Approx. Wgt.	CE	Approx. Wgt.
Inches	Inches	Inches	Lbs.	Inches	Lbs.	Inches	Lbs.
25	33.4	57	0.3	57	0.5	57	0.6
1	1.315	2.25	0.66	2.25	1.10	2.25	1.32
32	42.4	70	0.5	70	0.7	70	1.0
1¼	1.660	2.75	1.10	2.75	1.54	2.75	2.20
40	48.3	70	0.5	70	0.9	70	1.1
1½	1.900	2.75	1.10	2.75	1.98	2.75	2.42
50	60.3	83	0.8	83	1.4	83	1.7
2	2.375	3.25	1.76	3.25	3.08	3.25	3.74
65	73.0	95	1.5	95	2.2	95	2.7
2½	2.875	3.75	3.30	3.75	4.85	3.75	5.95
65	76.1	95	1.7	95	2.4	95	2.8
2½	3.000	3.75	3.74	3.75	5.29	3.75	6.17
80	88.9	108	2.0	108	3.0	108	4.8
3	3.500	4.25	4.41	4.25	6.61	4.25	10.57
100	108.0	127	3.0	127	5.2	127	7.1
4	4.250	5.00	6.61	5.00	11.45	5.00	15.64
100	114.3	127	3.2	127	5.4	127	7.2
4	4.500	5.00	7.05	5.00	11.89	5.00	15.86
125	133.0	140	5.3	140	8.0	140	9.0
5	5.250	5.50	11.67	5.50	17.62	5.50	19.82
125	139.7	140	5.3	140	8.1	140	9.1
5	5.500	5.50	11.67	5.50	17.84	5.50	20.04
125	141.3	140	5.3	140	8.1	140	9.2
5	5.563	5.50	11.67	5.50	17.84	5.50	20.26
150	159.0	165	7.8	165	10.1	165	12.6
6	6.250	6.50	17.18	6.50	22.25	6.50	27.75
150	165.1	165	7.8	165	10.3	165	12.7
6	6.500	6.50	17.18	6.50	22.69	6.50	27.97
150	168.3	165	7.8	165	10.4	165	12.7
6	6.625	6.50	17.18	6.50	22.91	6.50	27.97
200	219.1	197	13.6	197	21.6	197	24.8
8	8.625	7.75	29.96	7.75	47.58	7.75	54.62
250	273.0	229	28.7	229	44.9	229	55.1
10	10.750	9.00	63.21	9.00	98.90	9.00	121.36
300	323.9	254	33.6	254	60.3	254	72.9
12	12.750	10.00	74.01	10.00	132.82	10.00	160.57

- **Housing material:** Ductile iron conforming to ASTM A-536, grade 65-45-12.
- **FM Approved & UL Listed:** R.W.P. rated working pressure 300PSI (2.065MPa / 20.65bars)
- **Housing Finish:** Fusion Bonded Epoxy Coated (Optional: Hot Deep Galvanized and Others)
- **Size Range:** DN25 through DN300 (1" through 12")



## Grooved Fittings

### 45° Elbow, 22.5° Elbow & 11.25° Elbow

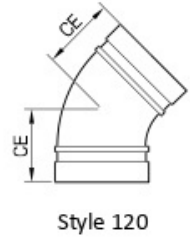

Style 120

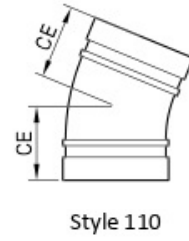

Style 110

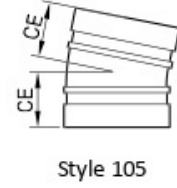

Style 105

#### Style 120 45° Elbow



#### Style 110 22.5° Elbow



#### Style 105 11.25° Elbow



Size		Style 120 45° Elbow		Style 110 22.5° Elbow		Style 105 11.25° Elbow	
Nominal Dia.	Actual O.D.	CE	Approx. Wgt.	CE	Approx. Wgt.	CE	Approx. Wgt.
DN	mm	mm	kg	mm	kg	mm	kg
Inches	Inches	Inches	Lbs.	Inches	Lbs.	Inches	Lbs.
25	33.4	44	0.3	44	0.2	35	0.2
1	1.315	1.75	0.66	1.75	0.44	1.38	0.44
32	424.	44	0.3	44	0.3	35	0.2
1 1/4	1.660	1.75	0.66	1.75	0.66	1.38	0.44
40	48.3	44	0.4	44	0.4	35	0.2
1 1/2	1.900	1.75	0.88	1.75	0.88	1.38	0.44
50	60.3	51	0.5	51	0.6	35	0.5
2	2.375	2.00	1.10	2.00	1.32	1.38	1.10
65	73.0	57	0.6	51	0.7	38	0.5
2 1/2	2.875	2.25	1.32	2.00	1.54	1.50	1.10
65	76.1	57	0.8	51	0.8	38	0.8
2 1/2	3.000	2.25	1.76	2.00	1.76	1.50	1.76
80	88.9	64	1.1	57	1.0	38	1.0
3	3.500	2.50	2.42	2.25	2.20	1.50	2.20
100	108.0	76	1.6	73	1.7	44	1.4
4	4.250	3.00	3.52	2.87	3.74	1.75	3.08
100	114.3	76	1.7	73	1.8	44	1.6
4	4.500	3.00	3.74	2.87	3.96	1.75	3.52
125	133.0	83	2.6	73	2.4	51	2.0
5	5.250	3.25	5.73	2.87	5.29	2.00	4.41
125	139.7	83	2.7	73	2.5	51	2.1
5	5.500	3.25	5.95	2.87	5.51	2.00	4.63
125	141.3	83	2.8	73	2.6	51	2.2
5	5.563	3.25	6.17	2.87	5.73	2.00	4.85
150	159.0	89	3.8	79	3.6	51	3.0
6	6.250	3.50	8.37	3.11	7.93	2.00	6.61
150	165.1	89	4.2	79	3.8	51	3.2
6	6.500	3.50	9.25	3.11	8.37	2.00	7.05
150	168.3	89	4.4	79	4.0	51	3.2
6	6.625	3.50	9.69	3.11	8.81	2.00	7.05
200	219.1	108	8.4	83	6.4	51	4.6
8	8.625	4.25	18.50	3.25	14.10	2.00	10.13
250	273.0	121	13.0	89	10.4	54	5.3
10	10.750	4.75	28.63	3.50	22.91	2.15	11.67
300	323.9	133	18.0	102	18.1	57	13.5
12	12.750	5.25	39.65	4.00	39.87	2.25	29.74

- **Housing material** : Ductile iron conforming to ASTM A-536, grade 65-45-12.
- **FM Approved & UL Listed** : R.W.P. rated working pressure 300PSI(2.065MPa / 20.65bars)
- **Housing Finish** : Fusion Bonded Epoxy Coated ( Optional : Hot Deep Galvanized and Others )
- **Coupling gasket material** : EPDM ( Optional : Nitrile NBR , Silicone and Others )
- In addition to the points listed in this table, but also according to customer requirements to provide a variety of special point of the elbow
- **Size Range** : DN25 through DN300 (1"through 12")

## Grooved Fittings

### End Cap & End Cap with Hole



Style 300

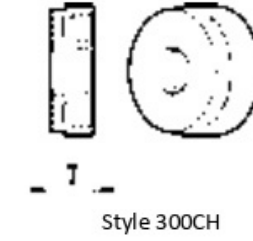

Style 300CH

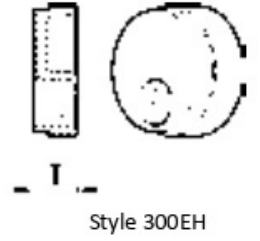

Style 300EH

#### Style 300 End Cap



#### Style 300CH End Cap With Center Hole



#### Style 300EH End Cap With Eccentric Hole



Size		Style 300 End Cap		Style 300CH End Cap With Center Hole		Style 300EH End Cap With Eccentric Hole	
Nominal Dia.	Actual O.D.	T	Approx. Wgt.	T	Approx. Wgt.	T	Approx. Wgt.
DN	mm	mm	kg	mm	kg	mm	kg
Inches	Inches	Inches	Lbs.	Inches	Lbs.	Inches	Lbs.
25	33.4	28	0.1	---	---	---	---
1	1.315	1.10	0.22	---	---	---	---
32	424.	28	0.13	---	---	---	---
1 1/4	1.660	1.10	0.29	---	---	---	---
40	48.3	28	0.15	---	---	---	---
1 1/2	1.900	1.10	0.33	---	---	---	---
50	60.3	37	0.22	25	0.31	25	0.25
2	2.375	1.46	0.48	1.00	0.68	1.00	0.55
65	73.0	37	0.3	25	0.36	25	0.36
2 1/2	2.875	1.46	0.66	1.00	0.79	1.00	0.79
65	76.1	37	0.32	25	0.38	25	0.38
2 1/2	3.000	1.46	0.7	1.00	0.84	1.00	0.84
80	88.9	41	0.41	25	0.52	25	0.52
3	3.500	1.61	0.9	1.00	1.15	1.00	1.15
100	108.0	51	0.69	25	0.8	25	0.8
4	4.250	2.00	1.52	1.00	1.76	1.00	1.76
100	114.3	51	0.71	25	0.82	25	0.82
4	4.500	2.00	1.56	1.00	1.81	1.00	1.81
125	133.0	51	1.04	25	1.15	25	1.15
5	5.250	2.00	2.29	1.00	2.53	1.00	2.53
125	139.7	51	1.11	25	1.23	25	1.23
5	5.500	2.00	2.44	1.00	2.71	1.00	2.71
125	141.3	51	1.12	25	1.24	25	1.24
5	5.563	2.00	2.47	1.00	2.73	1.00	2.73
150	159.0	55	1.38	25	1.56	25	1.56
6	6.250	2.17	3.04	1.00	3.44	1.00	3.44
150	165.1	55	1.45	25	1.68	25	1.68
6	6.500	2.17	3.19	1.00	3.7	1.00	3.7
150	168.3	55	1.51	25	1.72	25	1.72
6	6.625	2.17	3.33	1.00	3.79	1.00	3.79
200	219.1	68	3.13	30	3.71	30	3.71
8	8.625	13.00	6.89	1.18	8.17	1.18	8.17
250	273.0	75	5.52	32	6.17	32	6.17
10	10.750	2.95	12.16	1.25	13.59	1.25	13.59
300	323.9	81	8.44	32	9.73	32	9.73
12	12.750	3.20	18.59	1.25	21.43	1.25	21.43

- **Housing material**:Ductile iron conforming to ASTM A-536, grade 65-45-12.
- **FM Approved & UL Listed**:R.W.P. rated working pressure 300PSI(2.065MPa / 20.65bars)
- **Housing Finish**:Fusion Bonded Epoxy Coated(Optional:Hot Deep Galvanized and Others)
- End cap standard thread is 1", for other specifications, please indicate on the order
- **Size Range**:DN25 through DN300 (1" through 12")



Grooved Fittings

## Style 90DE 90° Drain Elbow with 1" Threaded

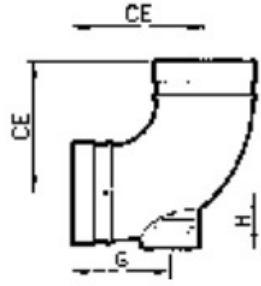

Style 90DE



Size		Style 90DE 90° Drain Elbow			
Nominal Dia.	Actual O.D.	CE	g	H	Approx. Wgt.
Inches	mm	mm	mm	mm	kg
50	60.3	83	57	40	0.68
2	2.375	3.25	2.25	1.57	1.5
65	73.0	95	70	40	1.08
2 1/2	2.875	3.75	1.79	1.57	2.38
65	76.1	95	70	40	1.12
2 1/2	3.000	3.75	1.79	1.57	2.47
80	88.9	108	70	49	1.47
3	3.500	4.25	1.79	1.93	3.24
100	108.0	127	70	63	2.38
4	4.250	5.00	1.79	2.48	5.24
100	114.3	127	70	63	2.41
4	4.500	5.00	1.79	2.48	5.31
125	133.0	140	70	76	4.26
5	5.250	5.50	1.79	3.00	9.38
125	139.7	140	70	76	4.34
5	5.500	5.50	1.79	3.00	9.56
125	141.3	140	70	76	4.38
5	5.563	5.50	1.79	3.00	9.65
150	159.0	165	70	90	5.53
6	6.250	6.50	1.79	3.54	12.18
150	165.1	165	70	90	5.6
6	6.500	6.50	1.79	3.54	12.33
150	168.3	165	70	90	5.71
6	6.625	6.50	1.79	3.54	12.58
200	219.1	197	84	114	10.79
8	8.625	7.75	3.31	4.50	23.77

- **Housing material** : Ductile iron conforming to ASTM A-536, grade 65-45-12.
- **FM Approved & UL Listed** : R.W.P. rated working pressure 300PSI(2.065MPa / 20.65bars)
- **Housing Finish** : Fusion Bonded Epoxy Coated ( Optional : Hot Deep Galvanized and Others )
- Hydrophobic port thread standard size is 1", for other specifications, please indicate on the order.
- **Size Range** : DN50 through DN200 (2"through 8")

## Style 90RT 90° Reducing Elbow with Threaded Small End (Add-a-cap)

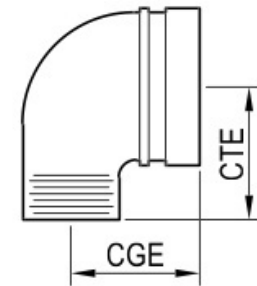

Style 90RT



Size		Style 90RT 90° Reducing Elbow			
Run Pipe	X Branch Pipe	C to GE	C to GE	Approx. Wgt.	
mm	X mm	mm	mm	kg	Lbs.
42.4	X 21.3	48	32	0.2	
1 1/4	1/2	1.90	1.26	0.44	
	3/4	2.00	1.34	0.2	
	3/4	2.00	1.34	0.44	
	1	2.17	1.46	0.3	
	1	2.17	1.46	0.66	
48.3	X 21.3	48	35	0.5	
1 1/2	1/2	1.90	1.38	1.10	
	3/4	2.00	1.46	0.5	
	3/4	2.00	1.46	1.10	
	1	2.17	1.57	0.6	
	1	2.17	1.57	1.32	
60.3	X 21.3	48	41	0.8	
2	1/2	1.90	1.60	1.76	
	3/4	2.00	1.70	0.8	
	3/4	2.00	1.70	1.76	
	1	2.17	1.80	0.9	
	1	2.17	1.80	1.98	
73.0	X 21.3	48	48	1.2	
2 1/2	1/2	1.90	1.90	2.64	
	3/4	2.00	1.97	1.3	
	3/4	2.00	1.97	2.86	
	1	2.17	2.10	1.4	
	1	2.17	2.10	3.08	
76.1	X 21.3	48	51	1.3	
2 1/2	1/2	1.90	2.00	2.86	
	3/4	2.00	2.10	1.4	
	3/4	2.00	2.10	3.08	
	1	2.17	2.20	1.5	
	1	2.17	2.20	3.30	

- **Housing material** : Ductile iron conforming to ASTM A-536, grade 65-45-12.
- **FM Approved & UL Listed** : R.W.P. rated working pressure 300PSI(2.065MPa / 20.65bars)
- **Housing Finish** : Fusion Bonded Epoxy Coated ( Optional : Hot Deep Galvanized and Others )
- **Size Range** : DN32 X DN15 through DN65 X DN25 (1 1/4" X 1/2" through 2 1/2" X 1")

Grooved Fittings

## Style 321G Flange Adaptor Nipple

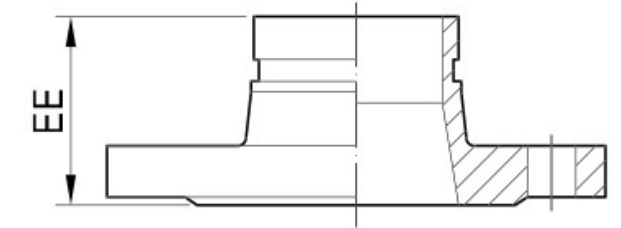

- Model 321G flanged adaptor is mainly used for the conversion connection of valves, equipment or pipes which interface with some flanges, which solves the conversion of the grooved connection and the flanged connection, and the installation is quick and easy.

- Model 321G flanged adaptor has bolt hole designed into an oval shape. ANSI Class 125 & 150 and PN16 grade flanges are universally available, with DN50 to DN80(2"to 3") for both PN10 and PN25 nominal flanges; DN100 to DN150 (4"to 6") for both flanges PN10 nominal grade flange.

- In addition to the above standard flanged short pipe products, other flange standards such as JIS 10K and ANSI Class 300 can also be supplied.

Size		EE	Approx. Wgt.	Size		EE	Approx. Wgt.
Nominal Dia.	Actual O.D.			Nominal Dia.	Actual O.D.		
mm	mm	mm	kg	DN	mm	mm	kg
Inches	Inches	Inches	Lbs.	Inches	Inches	Inches	Lbs.
50	60.3	70	1.5	125	141.3	80	4.0
2	2.375	2.75	3.30	5	5.563	3.15	8.80
65	73.0	70	1.9	150	165.1	100	5.9
2 1/2	2.875	2.75	4.18	6	6.500	3.94	12.98
65	76.1	70	1.9	150	168.3	100	5.9
2 1/2	3.000	2.75	4.18	6	6.625	3.94	12.98
80	88.9	70	2.3	200	219.1	100	9.2
3	3.500	2.75	5.06	8	8.625	3.94	20.24
100	114.3	80	3.5	250	273.0	100	21.5
4	4.500	3.15	7.70	10	10.750	3.94	67.3
125	139.7	80	4.0	300	323.9	100	31.5
5	5.500	3.15	8.80	12	12.750	3.94	69.3

- **Housing material**: Ductile iron conforming to ASTM A-536, grade 65-45-12.
- **FM Approved & UL Listed**: R.W.P. rated working pressure 300PSI(2.065MPa / 20.65bars)
- **Housing Finish**: Fusion Bonded Epoxy Coated(Optional: Hot Deep Galvanized and Others)
- **Size Range**: DN50 through DN300 (2"through 12")



## Grooved Fittings

### Nipple

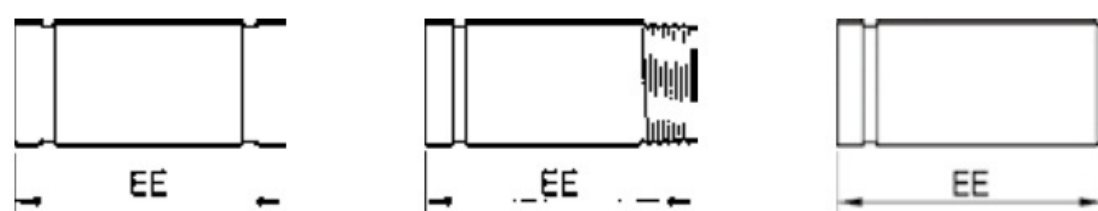

Style 018GG

Style 018GT

Style 018GB

- The table EE value is the standard value, but can also be customized according to user requirements length
- Nipple's wall thickness is the standard US' SCH40 thickness, but also according to user requirements choose a different wall thickness
- Standard cutting groove, but also can do the rolling groove

Size		Style 018GG Grooved X Grooved Nipple		Style 018GT Grooved X Threaded Nipple		Style 018GB Grooved X Bevel Nipple	
Nominal Dia.	Actual O.D.	EE	Approx. Wgt.	EE	Approx. Wgt.	EE	Approx. Wgt.
DN	mm	mm	kg	mm	kg	mm	kg
Inches	Inches	Inches	Lbs.	Inches	Lbs.	Inches	Lbs.
25	33.4	76	0.19	76	0.19	76	0.19
1	1.315	3.00	0.42	3.00	0.42	3.00	0.42
32	42.4	102	0.35	102	0.35	102	0.35
1 1/4	1.660	4.00	0.77	4.00	0.77	4.00	0.77
40	48.3	102	0.41	102	0.41	102	0.41
1 1/2	1.900	4.00	0.91	4.00	0.91	4.00	0.91
50	60.3	102	0.55	102	0.55	102	0.55
2	2.375	4.00	1.22	4.00	1.22	4.00	1.22
65	73.0	102	0.88	102	0.88	102	0.88
2 1/2	2.875	4.00	1.94	4.00	1.94	4.00	1.94
65	76.1	102	0.92	102	0.92	102	0.92
2 1/2	3.000	4.00	2.03	4.00	2.03	4.00	2.03
80	88.9	102	1.15	102	1.15	102	1.15
3	3.500	4.00	2.54	4.00	2.54	4.00	2.54
100	108.0	152	2.3	---	---	152	2.3
4	4.250	6.00	5.07	---	---	6.00	5.07
100	114.3	152	2.44	---	---	152	2.44
4	4.500	6.00	5.38	---	---	6.00	5.38
125	133.0	152	3.1	---	---	152	3.1
5	5.250	6.00	6.84	---	---	6.00	6.84
125	139.7	152	3.27	---	---	152	3.27
5	5.500	6.00	7.2	---	---	6.00	7.2
125	141.3	152	3.31	---	---	152	3.31
5	5.563	6.00	7.29	---	---	6.00	7.29
150	159.0	152	4.05	---	---	152	4.05
6	6.250	6.00	8.92	---	---	6.00	8.92
150	165.1	152	4.21	---	---	152	4.21
6	6.500	6.00	9.27	---	---	6.00	9.27
150	168.3	152	4.3	---	---	152	4.3
6	6.625	6.00	9.46	---	---	6.00	9.46
200	219.1	152	6.47	---	---	152	6.47
8	8.625	6.00	14.25	---	---	6.00	14.25
250	273.0	203	12.24	---	---	203	12.24
10	10.750	8.00	26.96	---	---	8.00	26.96
300	323.9	203	16.19	---	---	203	16.19
12	12.750	8.00	35.65	---	---	8.00	35.65

- Housing material : Steel
- Housing Finish : Fusion Bonded Epoxy Coated ( Optional : Hot Deep Galvanized and Others )
- Size Range : DN25 through DN300 (1" through 12")

## Grooved Fittings

### Concentric Reducer



Style 240 Grooved Concentric Reducer



Style 240N Threaded Concentric Reducer

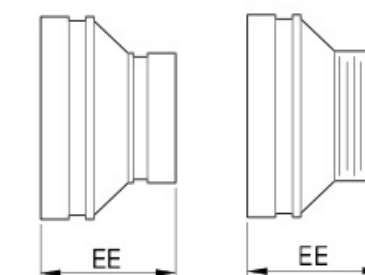

Style 240

Style 240N



Size			Style 240 Concentric Reducer		Style 240N Concentric Reducer	
Run Pipe	X	Branch Pipe	EE	Approx. Wgt.	EE	Approx. Wgt.
mm	X	mm	mm	kg	mm	kg
Inches	X	Inches	Inches	Lbs.	Inches	Lbs.
42.4	X	33.4	64	0.2	64	0.3
1 1/4		1	2.50	0.44	2.50	0.66
48.3	X	33.4	64	0.3	64	0.3
1 1/2		1	2.50	0.66	2.50	0.66
		42.4	64	0.3	64	0.4
		1 1/4	2.50	0.66	2.50	0.88
60.3	X	33.4	64	0.3	64	0.4
2		1	2.50	0.66	2.50	0.88
		42.4	64	0.4	64	0.4
		1 1/4	2.50	0.88	2.50	0.88
		48.3	64	0.4	64	0.4
		1 1/2	2.50	0.88	2.50	0.88
73.0	X	33.4	64	0.5	64	0.5
2 1/2		1	2.50	1.10	2.50	1.10
		42.4	64	0.5	64	0.5
		1 1/4	2.50	1.10	2.50	1.10
		48.3	64	0.5	64	0.5
		1 1/2	2.50	1.10	2.50	1.10
60.3	X	33.4	64	0.5	64	0.5
2 1/2		1	2.50	1.10	2.50	1.10
		42.4	64	0.5	64	0.5
		1 1/4	2.50	1.10	2.50	1.10
		48.3	64	0.5	64	0.5
		1 1/2	2.50	1.10	2.50	1.10
76.1	X	33.4	64	0.5	64	0.5
2 1/2		1 1/2	2.50	1.10	2.50	1.10
		42.4	64	0.5	64	0.5
		1 1/4	2.50	1.10	2.50	1.10
		48.3	64	0.5	64	0.6
		1 1/2	2.50	1.10	2.50	1.32
		60.3	64	0.6	64	0.6
		2	2.50	1.32	2.50	1.32
88.9	X	33.4	64	0.6	64	0.6
3		1	2.50	1.32	2.50	1.32
		42.4	64	0.6	64	0.6
		1 1/4	2.50	1.32	2.50	1.32
		48.3	64	0.6	64	0.7
		1 1/2	2.50	1.32	2.50	1.54

- Housing material: Ductile iron conforming to ASTM A-536, grade 65-45-12.
- FM Approved & UL Listed: R.W.P. rated working pressure 300PSI (2.065MPa/20.65bars)
- Housing Finish: Fusion Bonded Epoxy Coated (Optional: Hot Deep Galvanized and Others)
- Size Range: DN32 X DN25 through DN300 X DN250 (1 1/4" X 1" through 12" X 10")

Size			Style 240 Concentric Reducer		Style 240N Concentric Reducer	
Run Pipe	X	Branch Pipe	EE	Approx. Wgt.	EE	Approx. Wgt.
mm	X	mm	mm	kg	mm	kg
Inches	X	Inches	Inches	Lbs.	Inches	Lbs.
88.9	X	60.3	64	0.7	64	0.7
3		2	2.50	1.54	2.50	1.54
		73.0	64	0.7	64	0.7
		2 1/2	2.50	1.54	2.50	1.54
		76.1	64	0.7	64	0.7
		2 1/2	2.50	1.54	2.50	1.54
114.3	X	33.4	76	0.9	76	0.9
4		1	3.00	1.98	3.00	1.98
		42.4	76	0.9	76	1.0
		1 1/4	3.00	1.98	3.00	2.20
		48.3	76	1.0	76	1.0
		1 1/2	3.00	2.20	3.00	2.20
		60.3	76	1.0	76	1.1
		2	3.00	2.20	3.00	2.42
		73.0	76	1.1	76	1.1
		2 1/2	3.00	2.42	3.00	2.42
		76.1	76	1.1	76	1.1
		2 1/2	3.00	2.42	3.00	2.42
		88.9	76	1.1	76	1.1
		3	3.00	2.42	3.00	2.42
139.7	X	33.4	89	1.4	89	1.4
5		1	3.50	3.08	3.50	3.08
		42.4	89	1.4	89	1.4
		1 1/4	3.50	3.08	3.50	3.08
		48.3	89	1.4	89	1.5
		1 1/2	3.50	3.08	3.50	3.30
		60.3	89	1.5	89	1.5
		2	3.50	3.30	3.50	3.30
		76.1	89	1.5	89	1.6
		2 1/2	3.50	3.30	3.50	3.52
		88.9	89	1.6	89	1.6
		3	3.50	3.52	3.50	3.52
		114.3	89	1.7	--	--
		4	3.50	3.74	--	--
141.3	X	33.4	89	1.4	89	1.4
5		1	3.50	3.08	3.50	3.08
		42.4	89	1.4	89	1.4
		1 1/4	3.50	3.08	3.50	3.08
		48.3	89	1.4	89	1.5
		1 1/2	3.50	3.08	3.50	3.30
		60.3	89	1.5	89	1.5
		2	3.50	3.30	3.50	3.30
		73.0	89	1.5	89	1.6
		2 1/2	3.50	3.30	3.50	3.52
		88.9	89	1.6	89	1.6
		3	3.50	3.52	3.50	3.52
		114.3	89	1.7	--	--
		4	3.50	3.74	--	--



## Grooved Fittings

### Concentric Reducer



Style 240 Grooved Concentric Reducer



Style 240N Threaded Concentric Reducer

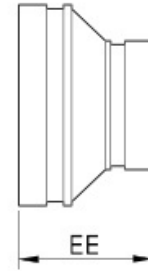

Style 240

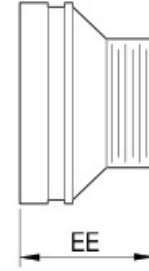

Style 240N

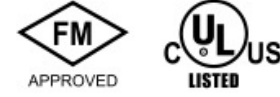

Size			Style 240 Concentric Reducer		Style 240N Concentric Reducer	
Run Pipe	X	Branch Pipe	EE	Approx. Wgt.	EE	Approx. Wgt.
mm	X	mm	mm	kg	mm	kg
Inches	X	Inches	Inches	Lbs.	Inches	Lbs.
165.1 6	X	33.4	102	2.1	102	2.1
		1	4.00	4.66	4.00	4.66
		42.4	102	2.1	102	2.2
		1/4	4.00	4.66	4.00	4.85
		48.3	102	2.2	102	2.2
		1/2	4.00	4.85	4.00	4.85
		60.3	102	2.2	102	2.3
		2	4.00	4.85	4.00	5.07
		76.1	102	2.3	102	2.3
		2 1/2	4.00	5.07	4.00	5.07
		88.9	102	2.3	102	2.4
		3	4.00	5.07	4.00	5.29
168.3 6	X	33.4	102	2.1	102	2.2
		1	4.00	4.66	4.00	4.85
		42.4	102	2.1	102	2.2
		1/4	4.00	4.66	4.00	4.85
		48.3	102	2.2	102	2.2
		1/2	4.00	4.85	4.00	4.85
		60.3	102	2.2	102	2.3
		2	4.00	4.85	4.00	5.07
		73.0	102	2.3	102	2.3
		2 1/2	4.00	5.07	4.00	5.07
		88.9	102	2.3	102	2.4
		3	4.00	5.07	4.00	5.29
219.1 8	X	33.4	127	4.1	127	4.2
		1	5.00	9.03	5.00	9.25
		141.3	127	4.2	127	4.3
		1/4	5.00	9.25	5.00	9.47
		48.3	127	4.2	127	4.3
		1/2	5.00	9.25	5.00	9.47
		60.3	127	4.3	127	4.4
		2	5.00	9.47	5.00	9.69
		73.0	127	4.3	127	4.4
		2 1/2	5.00	9.47	5.00	9.69

Size			Style 240 Concentric Reducer		Style 240N Concentric Reducer	
Run Pipe	X	Branch Pipe	EE	Approx. Wgt.	EE	Approx. Wgt.
mm	X	mm	mm	kg	mm	kg
Inches	X	Inches	Inches	Lbs.	Inches	Lbs.
219.1 8	X	76.1	127	4.3	127	4.5
		2 1/2	5.00	9.47	5.00	9.91
		88.9	127	4.5	127	4.5
		3	5.00	9.91	5.00	9.91
		114.3	127	4.6	--	--
		4	5.00	10.13	--	--
		139.7	127	4.8	--	--
		5	5.00	10.57	--	--
		141.3	127	4.8	--	--
		5	5.00	10.57	--	--
		165.1	127	5.0	--	--
		6	5.00	11.00	--	--
273.0 10	X	114.3	152	7.5	--	--
		4	6.00	16.52	--	--
		139.7	152	7.6	--	--
		5	6.00	16.74	--	--
		141.3	152	7.6	--	--
		5	6.00	16.74	--	--
		165.1	152	7.8	--	--
		6	6.00	17.18	--	--
		168.3	152	7.8	--	--
		6	6.00	17.18	--	--
		219.1	152	8.8	--	--
		8	6.00	19.38	--	--
323.9 12	X	114.3	178	9.9	--	--
		4	7.00	21.81	--	--
		139.7	178	10.0	--	--
		5	7.00	22.03	--	--
		141.3	178	10.0	--	--
		5	7.00	22.03	--	--
		165.1	178	10.2	--	--
		6	7.00	22.47	--	--
		168.3	178	10.3	--	--
		6	7.00	22.69	--	--
		219.1	178	11.2	--	--
		8	7.00	24.67	--	--
273.0 10	X	178	13.8	--	--	
		7.00	30.40	--	--	

## Grooved Fittings

### Reducing Tee



Style 131 Grooved Reducing Tee



Style 131N Threaded Reducing Tee

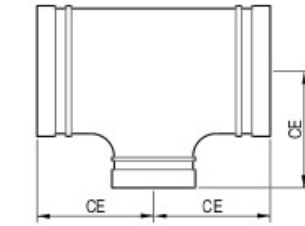

Style 131

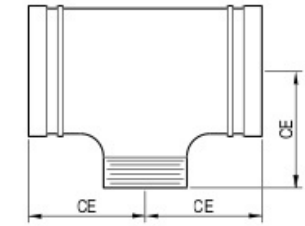

Style 131N



Size			Style 131 Reducing Tee		Style 131N Reducing Tee			
Run Pipe	X	Branch Pipe	EE	Approx. Wgt.	EE	Approx. Wgt.		
mm	X	mm	mm	kg	mm	kg		
Inches	X	Inches	Inches	Lbs.	Inches	Lbs.		
42.4 1 1/4	X	33.4	57	0.5	57	0.6		
		1	2.25	1.10	2.25	1.32		
		48.3	70	0.6	70	0.6		
		1 1/2	1	2.75	1.32	2.75	1.32	
		42.4	70	0.7	70	0.7		
		1 1/4	2.75	1.54	2.75	1.54		
		60.3 2	X	33.4	70	0.7	70	0.8
				1	2.75	1.54	2.75	1.76
				42.4	70	0.8	70	0.8
				1 1/4	2.75	1.76	2.75	1.76
				48.3	70	0.8	70	0.8
				1 1/2	2.75	1.76	2.75	1.76
73.0 2 1/2	X			33.4	76	1.1	76	1.1
				1	3.00	2.42	3.00	2.42
				42.4	76	1.1	76	1.1
				1 1/4	3.00	2.42	3.00	2.42
				48.3	76	1.2	76	1.2
				1 1/2	3.00	2.64	3.00	2.64
		60.3	76	1.2	76	1.2		
		2	3.00	2.64	3.00	2.64		
		76.1	76	1.2	76	1.2		
		2 1/2	3.00	2.64	3.00	2.64		
		42.4	76	1.2	76	1.3		
		1 1/4	3.00	2.64	3.00	2.86		
88.9 3	X	33.4	86	1.4	86	1.4		
		1	3.40	3.08	3.40	3.08		
		42.4	86	1.4	86	1.5		
		1 1/4	3.40	3.08	3.40	3.30		
		48.3	86	1.5	86	1.6		
		1 1/2	3.40	3.30	3.40	3.52		
		60.3	86	1.6	86	1.6		
		2	3.40	3.52	3.40	3.52		
		73.0	86	1.6	86	1.6		
		2 1/2	3.40	3.52	3.40	3.52		
		76.1	86	1.6	86	1.6		
		2 1/2	3.40	3.52	3.40	3.52		

Size			Style 131 Reducing Tee		Style 131N Reducing Tee	
Run Pipe	X	Branch Pipe	EE	Approx. Wgt.	EE	Approx. Wgt.
mm	X	mm	mm	kg	mm	kg
Inches	X	Inches	Inches	Lbs.	Inches	Lbs.
114.3 4	X	33.4	102	2.5	102	2.5
		1	4.00	5.51	4.00	5.51
		42.4	102	2.5	102	2.5
		1 1/4	4.00	5.51	4.00	5.51
		48.3	102	2.5	102	2.6
		1 1/2	4.00	5.51	4.00	5.73
		60.3	102	2.6	102	2.6
		2	4.00	5.73	4.00	5.73
		73.0	102	2.6	102	2.7
		2 1/2	4.00	5.73	4.00	5.95
		76.1	102	2.6	102	2.7
		2 1/2	4.00	5.73	4.00	5.95
139.7 5	X	33.4	124	4.1	124	4.1
		1	4.88	9.03	4.88	9.03
		42.4	124	4.1	124	4.2
		1 1/4	4.88	9.03	4.88	9.25
		48.3	124	4.2	124	4.3
		1 1/2	4.88	9.25	4.88	9.47
		60.3	124	4.3	124	4.3
		2	4.88	9.47	4.88	9.47
		76.1	124	4.4	124	4.4
		2 1/2	4.88	9.69	4.88	9.69
		88.9	124	4.5	124	4.6
		3	4.88	9.91	4.88	10.13
141.3 5	X	33.4	124	4.6	--	--
		4	4.88	10.13	--	--
		33.4	124	4.1	124	4.1
		1	4.88	9.03	4.88	9.03
		42.4	124	4.1	124	4.2
		1 1/4	4.88	9.03	4.88	9.25
		48.3	124	4.2	124	4.3
		1 1/2	4.88	9.25	4.88	9.47
		60.3	124	4.3	124	4.3
		2	4.88	9.47	4.88	9.47
		73.0	124	4.4	124	4.4
		2 1/2	4.88	9.69	4.88	9.69
88.9	124	4.5	124	4.6		
3	4.88	9.91	4.88	10.13		
114.3 4	X	124	4.6	--	--	
		4.88	10.13	--	--	

- Housing material: Ductile iron conforming to ASTM A-536, grade 65-45-12.
- FM Approved & UL Listed: R.W.P. rated working pressure 300PSI (2.065MPa / 20.65kgf/cm<sup>2</sup>)
- Housing Finish: Fusion Bonded Epoxy Coated (Optional: Hot Deep Galvanized and Others)
- Size Range: DN32 X DN25 through DN300 X DN250 (1 1/4" X 1" through 12" X 10")



## Grooved Fittings

### Reducing Tee



Style 131 Grooved Reducing Tee



Style 131N Threaded Reducing Tee

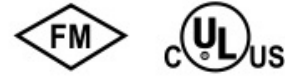
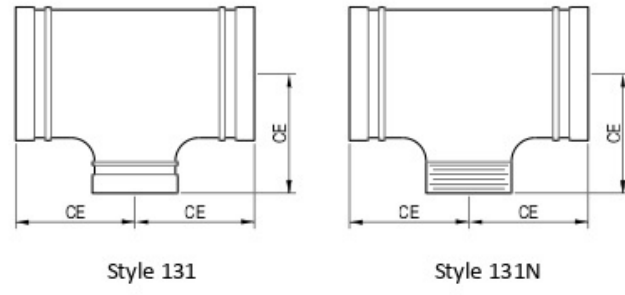

Size			Style 131 Reducing Tee		Style 131N Reducing Tee	
Run Pipe	X	Branch Pipe	EE	Approx. Wgt.	EE	Approx. Wgt.
mm	X	mm	mm	kg	mm	kg
Inches	X	Inches	Inches	Lbs.	Inches	Lbs.
165.1 6	X	33.4	140	6.3	140	6.3
		1	5.50	13.88	5.50	13.88
		42.4	140	6.3	140	6.4
		1/4	5.50	13.88	5.50	14.10
		48.3	140	6.3	140	6.4
		1/2	5.50	13.88	5.50	14.10
		60.3	140	6.4	140	6.4
		2	5.50	14.10	5.50	14.10
		76.1	140	6.4	140	6.5
		2 1/2	5.50	14.10	5.50	14.32
		88.9	140	6.5	140	6.5
		3	5.50	14.32	5.50	14.32
		114.3	140	6.7	--	--
		4	5.50	14.76	--	--
139.7	140	6.9	--	--		
5	5.50	15.20	--	--		
168.3 6	X	33.4	140	6.3	140	6.3
		1	5.50	13.88	5.50	13.88
		42.4	140	6.3	140	6.4
		1/4	5.50	13.88	5.50	14.10
		48.3	140	6.3	140	6.4
		1/2	5.50	13.88	5.50	14.10
		60.3	140	6.4	140	6.4
		2	5.50	14.10	5.50	14.10
		73.0	140	6.4	140	6.5
		2 1/2	5.50	14.10	5.50	14.32
		88.9	140	6.5	140	6.5
		3	5.50	14.32	5.50	14.32
		114.3	140	6.7	--	--
		4	5.50	14.76	--	--
114.3	140	6.9	--	--		
5	5.50	15.20	--	--		
219.1 8	X	33.4	173	11.1	173	11.1
		1	6.80	24.45	6.80	24.45
		42.4	173	11.3	173	11.4
		1/4	6.80	24.89	6.80	25.11
		48.3	173	11.5	173	11.6
		1/2	6.80	25.33	6.80	25.55
		60.3	173	11.9	173	12.0
		2	6.80	26.21	6.80	26.43
		73.0	173	12.0	173	12.1
		2 1/2	6.80	26.43	6.80	26.65

Size			Style 131 Reducing Tee		Style 131N Reducing Tee			
Run Pipe	X	Branch Pipe	EE	Approx. Wgt.	EE	Approx. Wgt.		
mm	X	mm	mm	kg	mm	kg		
Inches	X	Inches	Inches	Lbs.	Inches	Lbs.		
219.1 8	X	76.1	173	12.1	173	12.2		
		2 1/2	6.80	26.65	6.80	26.87		
		88.9	173	12.1	173	12.3		
		3	6.80	26.65	6.80	27.09		
		114.3	173	12.3	--	--		
		4	6.80	27.09	--	--		
		139.7	173	12.5	--	--		
		5	6.80	27.53	--	--		
		141.3	173	12.5	--	--		
		5	6.80	27.53	--	--		
		165.1	173	12.7	--	--		
		6	6.80	27.97	--	--		
		168.3	173	12.8	--	--		
		6	6.80	28.19	--	--		
273.0 10	X	114.3	229	21.5	--	--		
		4	9.00	47.36	--	--		
		139.7	229	23.8	--	--		
		5	9.00	52.42	--	--		
		141.3	229	23.8	--	--		
		5	9.00	52.42	--	--		
		165.1	229	25.4	--	--		
		6	9.00	55.95	--	--		
		168.3	229	25.4	--	--		
		6	9.00	55.95	--	--		
		219.1	229	26.3	--	--		
		8	9.00	57.93	--	--		
		323.9 12	X	114.3	254	29.1	--	--
				4	10.00	64.10	--	--
139.7	254			31.2	--	--		
5	10.00			68.72	--	--		
141.3	254			31.2	--	--		
5	10.00			68.72	--	--		
165.1	254			32.9	--	--		
6	10.00			72.47	--	--		
168.3	254			32.9	--	--		
6	10.00			72.47	--	--		
219.1	254			33.7	--	--		
8	10.00			74.23	--	--		
273.0	254			34.3	--	--		
10	10.00			75.55	--	--		

## Grooved Fittings

### Eccentric Reducer



Style 230 Grooved Eccentric Reducer



Style 230N Threaded Eccentric Reducer

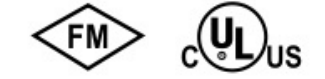

Size			Style 230 Eccentric Reducer		Style 230N Eccentric Reducer					
Run Pipe	X	Branch Pipe	EE	Approx. Wgt.	EE	Approx. Wgt.				
mm	X	mm	mm	kg	mm	kg				
Inches	X	Inches	Inches	Lbs.	Inches	Lbs.				
42.4 1 1/4	X	33.4	64	0.2	64	0.3				
		1	2.50	0.44	2.50	0.66				
		48.3	64	0.3	64	0.3				
		1 1/2	2.50	0.66	2.50	0.66				
		42.4	64	0.3	64	0.4				
		1 1/4	2.50	0.66	2.50	0.88				
		60.3 2	X	33.4	64	0.3	64	0.4		
				1	2.50	0.66	2.50	0.88		
				42.4	64	0.4	64	0.4		
				1 1/4	2.50	0.88	2.50	0.88		
				48.3	64	0.4	64	0.4		
				1 1/2	2.50	0.88	2.50	0.88		
				73.0 2 1/2	X	33.4	64	0.5	64	0.5
						1	2.50	1.10	2.50	1.10
42.4	64					0.5	64	0.5		
1 1/4	2.50					1.10	2.50	1.10		
48.3	64					0.5	64	0.5		
1 1/2	2.50					1.10	2.50	1.10		
60.3	64					0.5	64	0.5		
2	2.50					1.10	2.50	1.10		
76.1 2 1/2	X	33.4	64			0.5	64	0.5		
		1/2	2.50			1.10	2.50	1.10		
		42.4	64			0.5	64	0.5		
		1 1/4	2.50			1.10	2.50	1.10		
		48.3	64			0.5	64	0.6		
		1 1/2	2.50			1.10	2.50	1.32		
		60.3	64	0.6	64	0.6				
		2	2.50	1.32	2.50	1.32				
		88.9 3	X	33.4	64	0.6	64	0.6		
				1	2.50	1.32	2.50	1.32		
				42.4	64	0.6	64	0.6		
				1 1/4	2.50	1.32	2.50	1.32		
				48.3	64	0.6	64	0.7		
				1 1/2	2.50	1.32	2.50	1.54		
60.3	64			0.7	64	0.7				
2	2.50			1.54	2.50	1.54				
73.0	64			0.7	64	0.7				
2 1/2	2.50			1.54	2.50	1.54				
76.1	64			0.7	64	0.7				
2 1/2	2.50			1.54	2.50	1.54				
108.0 4	X			33.4	76	0.9	76	0.9		
				1	3.00	1.98	3.00	1.98		
		42.4	76	0.9	76	1.0				
		1 1/4	3.00	1.98	3.00	2.20				
		48.3	76	1.0	76	1.0				
		1 1/2	3.00	2.20	3.00	2.20				

Size			Style 230 Eccentric Reducer		Style 230N Eccentric Reducer			
Run Pipe	X	Branch Pipe	EE	Approx. Wgt.	EE	Approx. Wgt.		
mm	X	mm	mm	kg	mm	kg		
Inches	X	Inches	Inches	Lbs.	Inches	Lbs.		
108.0 4	X	60.3	76	1.0	76	1.1		
		2	3.00	2.20	3.00	2.42		
		76.1	76	1.1	76	1.1		
		2 1/2	3.00	2.42	3.00	2.42		
		88.9	76	1.1	76	1.1		
		3	3.00	2.42	3.00	2.42		
		114.3 4	X	33.4	76	0.9	76	0.9
				1	3.00	1.98	3.00	1.98
				42.4	76	0.9	76	1.0
				1 1/4	3.00	1.98	3.00	2.20
				48.3	76	1.0	76	1.0
				1 1/2	3.00	2.20	3.00	2.20
				60.3	76	1.0	76	1.1
				2	3.00	2.20	3.00	2.42
73.0	76			1.1	76	1.1		
2 1/2	3.00			2.42	3.00	2.42		
76.1	76			1.1	76	1.1		
2 1/2	3.00			2.42	3.00	2.42		
88.9	76			1.1	76	1.1		
3	3.00			2.42	3.00	2.42		
133.0 5	X	60.3	89	1.5	89	1.5		
		2	3.50	3.30	3.50	3.30		
		76.1	89	1.5	89	1.5		
		2 1/2	3.50	3.30	3.50	3.30		
		88.9	89	1.6	89	1.6		
		3	3.50	3.52	3.50	3.52		
		108.0	89	1.7	--	--		
		4	3.50	3.74	--	--		
		114.3	89	1.7	--	--		
		4	3.50	3.74	--	--		
		139.7 5	X	60.3	89	1.5	89	1.5
				2	3.50	3.30	3.50	3.30
				76.1	89	1.5	89	1.5
				2 1/2	3.50	3.30	3.50	3.30
88.9	89			1.6	89	1.6		
3	3.50			3.52	3.50	3.52		
108.0	89			1.7	--	--		
4	3.50			3.74	--	--		
114.3	89			1.7	--	--		
4	3.50			3.74	--	--		
141.3 5	X			60.3	89	1.5	89	1.5
				2	3.50	3.30	3.50	3.30
				73.0	89	1.5	89	1.6
				2 1/2	3.50	3.30	3.50	3.52
		88.9	89	1.6	89	1.6		
		3	3.50	3.52	3.50	3.52		
		108.0	89	1.7	--	--		
		4	3.50	3.74	--	--		
		114.3	89	1.7	--	--		
		4	3.50	3.74	--	--		



## Grooved Fittings

### Eccentric Reducer



Style 230 Grooved Eccentric Reducer

Style 230N Threaded Eccentric Reducer

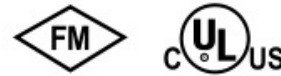

Size			Style 230 Eccentric Reducer		Style 230N Eccentric Reducer			
Run Pipe	X	Branch Pipe	EE	Approx. Wgt.	EE	Approx. Wgt.		
mm	X	mm	mm	kg	mm	kg		
Inches	X	Inches	Inches	Lbs.	Inches	Lbs.		
159.0 6	X	60.3	102	2.2	102	2.3		
		2	4.00	4.85	4.00	5.07		
		76.1	102	2.3	102	2.3		
		2 1/2	4.00	5.07	4.00	5.07		
		88.9	102	2.3	102	2.4		
		3	4.00	5.07	4.00	5.29		
		108.0	102	2.4	--	--		
		4	4.00	5.29	--	--		
		114.3	102	2.4	--	--		
		4	4.00	5.29	--	--		
		133.0	102	2.7	--	--		
		5	4.00	5.99	--	--		
165.1 6	X	60.3	102	2.2	102	2.3		
		2	4.00	4.85	4.00	5.07		
		76.1	102	2.3	102	2.3		
		2 1/2	4.00	5.07	4.00	5.07		
		88.9	102	2.3	102	2.4		
		3	4.00	5.07	4.00	5.29		
		108.0	102	2.4	--	--		
		4	4.00	5.29	--	--		
		114.3	102	2.4	--	--		
		4	4.00	5.29	--	--		
		133.0	102	2.7	--	--		
		5	4.00	5.99	--	--		
168.3 6	X	60.3	102	2.2	102	2.3		
		2	4.00	4.85	4.00	5.07		
		73.0	102	2.3	102	2.3		
		2 1/2	4.00	5.07	4.00	5.07		
		88.9	102	2.3	102	2.4		
		3	4.00	5.07	4.00	5.29		
		114.3	102	2.4	--	--		
		4	4.00	5.29	--	--		
		141.3	102	2.7	--	--		
		5	4.00	5.99	--	--		
		219.1 8	X	60.3	127	4.3	127	4.4
				2	5.00	9.47	5.00	9.69
73.0	127			4.3	127	4.4		
2 1/2	5.00			9.47	5.00	9.69		
76.1	127			4.3	127	4.5		
2 1/2	5.00			9.47	5.00	9.91		
88.9	127			4.5	127	4.5		
3	5.00			9.91	5.00	9.91		
108.0	127			4.6	--	--		
4	5.00			10.13	--	--		

- Housing material: Ductile iron conforming to ASTM A-536, grade 65-45-12.
- FM Approved & UL Listed: R.W.P. rated working pressure 300PSI (2.065MPa / 20.65kgf/cm<sup>2</sup>)
- Housing Finish: Fusion Bonded Epoxy Coated (Optional: Hot Deep Galvanized and Others)
- Size Range: DN32 X DN25 through DN300 X DN250 (1 1/4" X 1" through 12" X 10")

## Grooved Fittings

### Specific Elbow

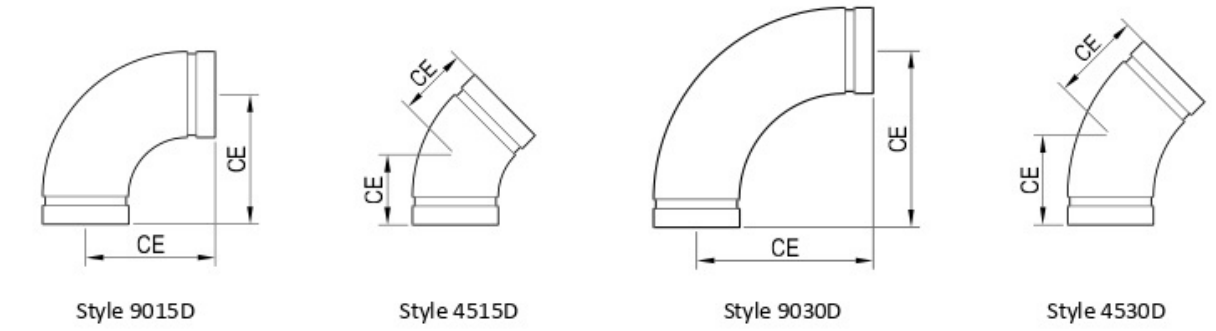

Style 9015D  
Long Radius 90° Elbows 1.5 D

Style 4515D  
Long Radius 45° Elbows 1.5 D

Style 9030D  
Long Radius 90° Elbows 3D

Style 4530D  
Long Radius 45° Elbows 3D

- All the products in this table are non-cast products made of steel pipe.
- In addition to the long radius of curvature listed in this table, other bend radius elbows are available upon request.

Size		Style 9015D 90° Elbow		Style 4515D 90° Elbow		Style 9030D 90° Elbow		Style 4530D 90° Elbow	
Nominal Dia.	Actual O.D.	CE	Approx. Wgt.	CE	Approx. Wgt.	CE	Approx. Wgt.	CE	Approx. Wgt.
DN	mm	mm	kg	mm	kg	mm	kg	mm	kg
Inches	Inches	Inches	Lbs.	Inches	Lbs.	Inches	Lbs.	Inches	Lbs.
50	60.3	111	1.1	70	0.8	254	2.3	165	2.1
	2	2.375	4.38	2.42	2.76	1.76	10.00	5.07	6.50
65	73.0	127	1.9	76	1.3	--	--	--	--
	2 1/2	2.875	5.00	4.18	3.00	2.86	--	--	--
65	76.1	127	1.9	76	1.3	--	--	--	--
	2 1/2	3.000	5.00	4.18	3.00	2.86	--	--	--
80	88.9	149	2.7	86	2.2	330	7.3	197	4.7
	3	3.500	5.87	5.95	3.40	4.85	13.00	16.08	7.75
100	108.0	--	--	--	--	--	--	--	--
	4	4.250	--	--	--	--	--	--	--
100	114.3	191	5.6	102	3.3	406	11.6	229	7.8
	4	4.500	7.52	12.33	4.00	7.27	16.00	25.55	9.00
125	133.0	--	--	--	--	--	--	--	--
	5	5.250	--	--	--	--	--	--	--
125	139.7	--	--	--	--	--	--	--	--
	5	5.500	--	--	--	--	--	--	--
125	141.3	--	--	--	--	--	--	--	--
	5	5.563	--	--	--	--	--	--	--
150	159.0	--	--	--	--	--	--	--	--
	6	6.250	--	--	--	--	--	--	--
150	165.1	273	13.2	140	8.6	610	30.8	343	19.8
	6	6.500	10.75	29.07	5.50	18.94	24.00	67.84	13.50
150	168.3	273	13.8	140	7.9	610	31.8	343	20.4
	6	6.625	10.75	30.40	5.50	17.40	24.00	70.04	13.50
200	219.1	362	30.0	159	16.3	--	--	--	--
	8	8.625	14.25	66.08	6.25	35.90	--	--	--
250	273.0	381	48.5	184	25.9	--	--	--	--
	10	10.750	15.00	106.83	7.25	57.05	--	--	--
300	323.9	457	70.8	191	40.8	--	--	--	--
	12	12.750	18.00	155.94	7.50	89.87	--	--	--

- Housing material: Steel
- Housing Finish: Fusion Bonded Epoxy Coated (Optional: Hot Deep Galvanized and Others)
- Size Range: DN50 through DN300 (2" through 12")



## Mechanical Outlets



- Branch outlet fitting is a supplement to the grooved piping system. It is a very important piping unit in the mechanical piping system. The appearance of the branch outlet fitting makes the installation of the piping system more convenient and quick. Branch outlet fittings replaced welding and reducing Tee, to solve the problem of the connection branch.
- Branch outlet fitting is another way of piping innovation, is the use of bolted connections branch pipe fittings. No need to weld directly from the supervisor on the branch pipe. The method used is in the need to take over the main branch pipe processing a round hole, fitted with branch outlet housing. The opening must be secured on the centerline of the pipe and be mechanically perforated by a dedicated opening.
- CNG branch outlet fitting, including mechanical tee, mechanical cross, U-bolt.

## Flow Date

The flow coefficient and flow resistance of the product at 16°C (60 F) are shown in the table on the right.

Since the pressure of the medium varies across the manifolds, the connection of the product functions best when the medium flows between ① and ②. As shown below.

The physical relationship between the various parameters under different pressures can be calculated from the formula on the right and from the data on the right.

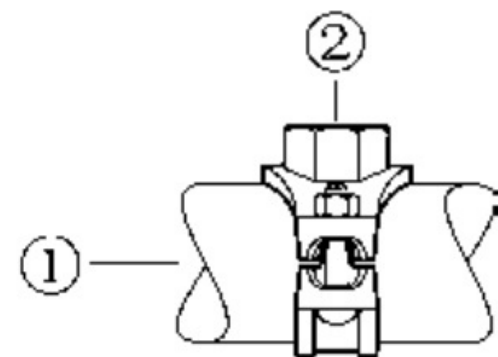

## Formulas for CV Values:

$$\Delta P = \frac{Q^2}{C_V^2}$$

$$Q = C_V \times \sqrt{\Delta P}$$

注:

$\Delta P$  : Pressure Drop , MPa

$Q$  : Flow , L/min

$C_V$  : Flow Coefficient

Size		C <sub>v</sub> Values	Equiv. of Pipe		Size		CV Values	Equiv. of Pipe	
Nominal Dia.	Actual O.D.		Grooved	Threaded	Nominal Dia.	Actual O.D.		Grooved	Threaded
DN Inches	mm Inches		m Feet	m Feet	DN Inches	mm Inches		m Feet	m Feet
15	21.3	775	---	0.6	65	73.0	6154	3.4	3.8
1/2	0.840		2.0	2 1/2	2.875	11.0		12.5	
20	26.9	957	---	1.2	65	76.1	6154	3.4	3.8
3/4	1.050		4.0	2 1/2	3.000	11.0		12.5	
25	33.4	1140	---	1.5	80	88.9	9117	4.1	4.7
1	1.315		5.0	3	3.500	13.5		15.5	
32	42.4	2051	1.7	1.8	100	108.0	18234	6.1	6.7
1 1/4	1.660		5.5	4	4.250	20.0		22.0	
40	48.3	2735	2.1	2.4	100	114.3	18234	6.1	6.7
1 1/2	1.900		7.0	4	4.500	20.0		22.0	
50	60.3	4558	2.7	3.2					
2	2.375		9.0						

## Mechanical Outlets

## Mechanical Cross



Mechanical cross description:

- ◆ Model 3GG grooved mechanical cross is built by 2 pieces of model 3G's outlet housing.
- ◆ Model 3JJ threaded mechanical cross is built by 2 pieces of model 3J's outlet housing

In the sprinkler system, the use of mechanical cross should be in accordance with the following principles, otherwise it will affect the strength of the pipeline:

All sizes of 3G / 3J mechanical tee can be combined into a mechanical cross, but must be combined according to certain principles, otherwise it will affect the strength of the pipeline, see the table on the right.

Run Pipe Size		Max. Branch Pipe Size			
Nominal Dia.	Actual O.D.	Mechanical Tee		Mechanical Cross	
		Nominal Dia.	Actual O.D.	Nominal Dia.	Actual O.D.
DN Inches	mm Inches	DN Inches	mm Inches	DN Inches	mm Inches
50	60.3	25	33.4	25	33.4
2	2.375	1	1.315	1	1.315
65	73.0	40	48.3	32	42.4
2 1/2	2.875	1 1/2	1.900	1 1/4	1.660
65	76.1	40	48.3	32	42.4
2 1/2	3.000	1 1/2	1.900	1 1/4	1.660
80	88.9	50	60.3	40	48.3
3	3.500	2	2.375	1 1/2	1.900
100	108.0	65	76.1	50	60.3
4	4.250	2 1/2	3.000	2	2.375
100	114.3	80	88.9	50	60.3
4	4.500	3	3.500	2	2.375
125	133.0	80	88.9	76.1	40
5	5.250	3	3.500	3.000	1 1/2
125	139.7	80	88.9	76.1	40
5	5.500	3	3.500	3.000	1 1/2
125	141.3	80	88.9	73.0	40
5	5.563	3	3.500	2.875	1 1/2
150	159.0	100	114.3	88.9	50
6	6.250	4	4.500	3.500	2
150	165.1	100	114.3	88.9	50
6	6.500	4	4.500	3.500	2
150	168.3	100	114.3	88.9	50
6	6.625	4	4.500	3.500	2
200	219.1	100	114.3	100	114.3
8	8.625	4	4.500	4	4.500



## Mechanical Outlets

- ◆ With mechanical outlet fittings, the branch pipe can be built directly from the main pipe without welding.
- ◆ Gasket designed with the pipe arc to pipe surface, so as to achieve a more ideal sealing effect.
- ◆ Hole cut must be ensured on the center line of the pipe and be perforated by hole saw.

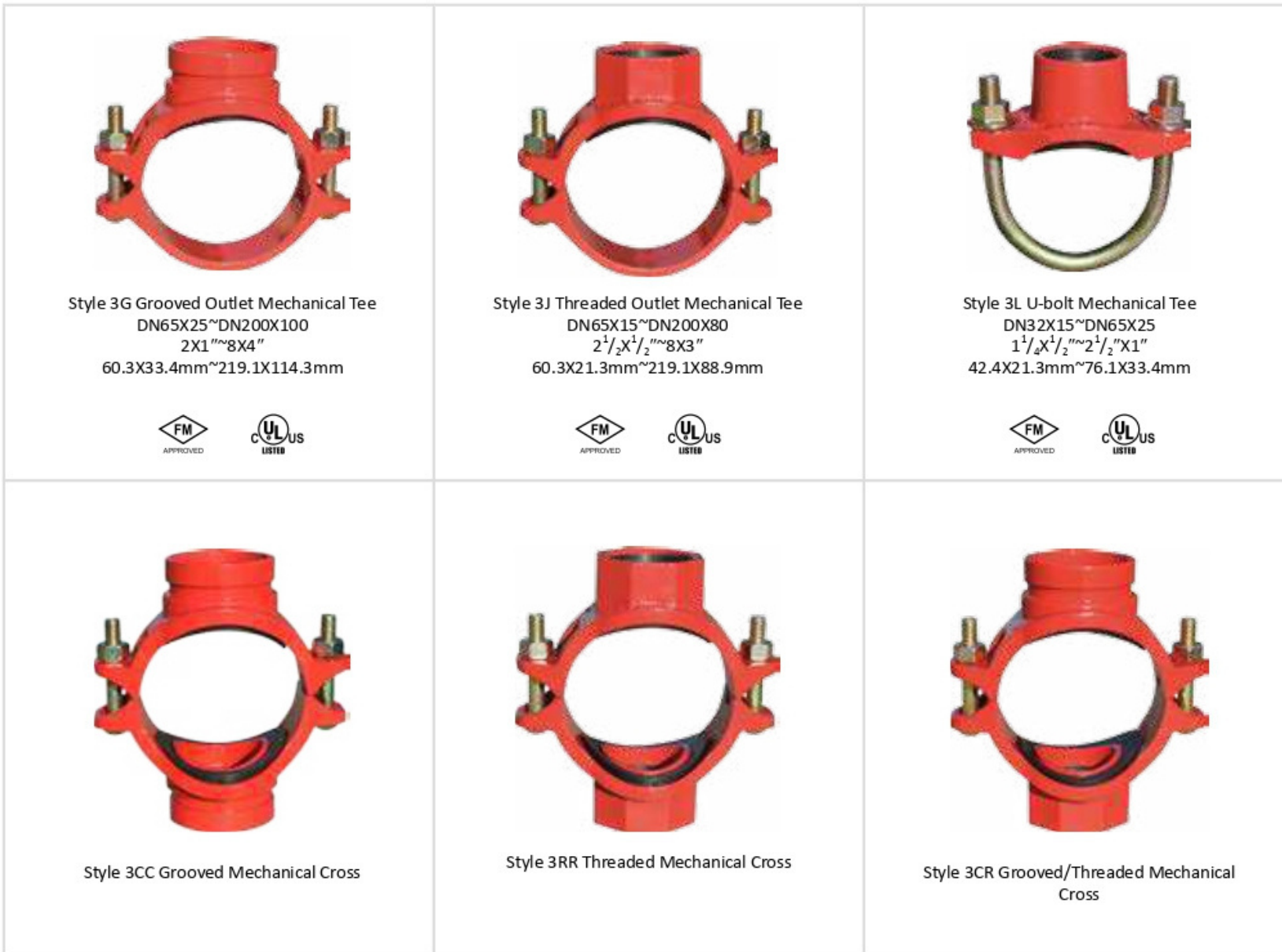

## Mechanical Outlets

### Mechanical Tee

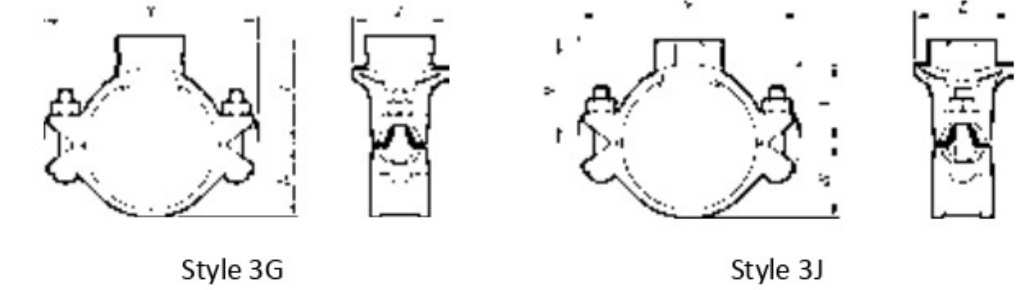

#### Style 3G Grooved Outlet Mechanical Tee



#### Style 3J Threaded Outlet Mechanical Tee



- By using the bolting method, the branch pipe is directly connected with the main pipe without welding.
- All products have 21.3mm (1/2") outlets and 26.9mm (3/4") outlets. All sizes is the same with 33.4mm (1") outlets.
- Enhanced body resists 4 times working pressure.

Size		Max. Work Pressure	Hole Size	Dimensions						Bolt/Nut Size	Approx. Wgt.		
Run Pipe	Branch Pipe			W	Y	Z	3G V	3J V	3J T		3G	3J	
mm	X	mm	mm	mm	mm	mm	mm	mm	mm	mm	kg	kg	
Inches	X	Inches	Inches	Inches	Inches	Inches	Inches	Inches	Inches	Inches	Lbs.	Lbs.	
60.3 2	X	33.4	3450	38	37	134	70	64	62	46	M12X65	0.85	0.81
		1	500	1.50	1.46	5.28	2.76	2.52	2.44	1.81	1/2 X 2 1/2	1.87	1.78
		42.4	3450	44.5	37	134	77	65	65	46	M12X65	0.89	0.92
		1 1/4	500	1.75	1.46	5.28	3.03	2.56	2.56	1.81	1/2 X 2 1/2	1.96	2.03
		48.3	3450	44.5	37	134	77	65	65	46	M12X65	0.91	0.98
		1 1/2	500	1.75	1.46	5.28	3.03	2.56	2.56	1.81	1/2 X 2 1/2	2.00	2.16
73.0 2 1/2	X	33.4	3450	38	43	148	68	74	64	46	M12X75	1.25	1.16
		1	500	1.50	1.69	5.83	2.68	2.91	2.52	1.81	1/2 X 3	2.75	2.56
		42.4	3450	44.5	43	148	76	74	67	46	M12X75	1.28	1.33
		1 1/4	500	1.75	1.69	5.83	2.99	2.91	2.64	1.81	1/2 X 3	2.82	2.93
		48.3	3450	51	43	148	83	74	67	46	M12X75	1.39	1.52
		1 1/2	500	2.00	1.69	5.83	3.27	2.91	2.64	1.81	1/2 X 3	3.06	3.35
76.1 2 1/2	X	33.4	3450	38	45	151	68	76	66	47	M12X75	1.19	1.17
		1	500	1.50	1.77	5.94	2.68	2.99	2.60	1.85	1/2 X 3	2.62	2.58
		42.4	3450	44.5	45	151	76	76	68	47	M12X75	1.22	1.27
		1 1/4	500	1.75	1.77	5.94	2.99	2.99	2.68	1.85	1/2 X 3	2.69	2.80
		48.3	3450	51	45	151	83	76	69	47	M12X75	1.27	1.33
		1 1/2	500	2.00	1.77	5.94	3.27	2.99	2.72	1.85	1/2 X 3	2.80	2.93
88.9 3	X	33.4	3450	38	52	161	68	82	72	54	M12X75	1.28	1.25
		1	500	1.50	2.05	6.34	2.68	3.23	2.83	2.13	1/2 X 3	2.82	2.75
		42.4	3450	44.5	52	161	75	82	74	54	M12X75	1.31	1.36
		1 1/4	500	1.75	2.05	6.34	2.95	3.23	2.91	2.13	1/2 X 3	2.89	3.00
		48.3	3450	51	52	161	82	82	75	54	M12X75	1.37	1.43
		1 1/2	500	2.00	2.05	6.34	3.23	3.23	2.95	2.13	1/2 X 3	3.02	3.15
108.0 4	X	33.4	3450	38	62	182	69	93	84	65	M12X75	1.48	1.44
		1	500	1.50	2.44	7.17	2.72	3.66	3.31	2.56	1/2 X 3	3.26	3.17
		42.4	3450	44.5	62	182	75	93	86	65	M12X75	1.52	1.56
		1 1/4	500	1.75	2.44	7.17	2.95	3.66	3.39	2.56	1/2 X 3	3.35	3.44
		48.3	3450	51	62	182	83	93	86	65	M12X75	1.59	1.64
		1 1/2	500	2.00	2.44	7.17	3.27	3.66	3.39	2.56	1/2 X 3	3.50	3.61
114.3 4	X	33.4	3450	38	65	188	69	96	87	68	M12X75	1.52	1.45
		1	500	1.50	2.56	7.40	2.72	3.78	3.43	2.68	1/2 X 3	3.35	3.19
		42.4	3450	44.5	65	188	75	96	89	68	M12X75	1.55	1.58
		1 1/4	500	1.75	2.56	7.40	2.95	3.78	3.50	2.68	1/2 X 3	3.41	3.48
		48.3	3450	51	65	188	83	96	89	68	M12X75	1.62	1.67
		1 1/2	500	2.00	2.56	7.40	3.27	3.78	3.50	2.68	1/2 X 3	3.57	3.68
127.0 5	X	33.4	3450	38	71	203	71	104	94	74	M12X75	1.75	1.75
		1	500	1.50	2.81	8.13	2.72	4.14	3.79	2.68	1/2 X 3	3.85	4.10
		42.4	3450	44.5	71	203	77	104	97	74	M12X75	1.81	1.86
		1 1/4	500	1.75	2.81	8.13	2.95	4.14	3.79	2.68	1/2 X 3	4.21	4.45
		48.3	3450	51	71	203	83	104	97	74	M12X75	1.91	2.02
		1 1/2	500	2.00	2.81	8.13	3.27	4.14	3.82	2.68	1/2 X 3	4.21	4.45
152.4 6	X	33.4	3450	38	81	229	71	119	104	81	M12X75	2.07	2.31
		1	500	1.50	3.15	8.81	2.72	4.76	4.25	2.68	1/2 X 3	4.56	5.09
		42.4	3450	44.5	81	229	77	119	107	81	M12X75	2.13	2.31
		1 1/4	500	1.75	3.15	8.81	2.95	4.76	4.25	2.68	1/2 X 3	4.69	5.09
		48.3	3450	51	81	229	83	119	107	81	M12X75	2.25	2.50
		1 1/2	500	2.00	3.15	8.81	3.27	4.76	4.25	2.68	1/2 X 3	4.69	5.09

- **Housing material:** Ductile iron conforming to ASTM A-536, grade 65-45-12.
- **FM Approved & UL Listed:** R.W.P. rated working pressure 300PSI(2.065MPa / 20.65bars)
- **Housing Finish:** Fusion Bonded Epoxy Coated(Optional:Hot Deep Galvanized and Others)
- **Coupling gasket material:** EPDM(Optional:Nitrile NBR,Silicone and Others)
- **Bolts and Nuts:** Heat treated and electro galvanized bolts with oval neck, and heavy duty hexagon nuts. Track head meeting the physical and chemical requirements of ASTM A-449 and physical requirements of ASTM A-183.
- **Size Range:** DN50 X DN25 through DN200 X DN100 (2" X 1" through 8" X 4")



## Mechanical Outlets

### Mechanical Tee

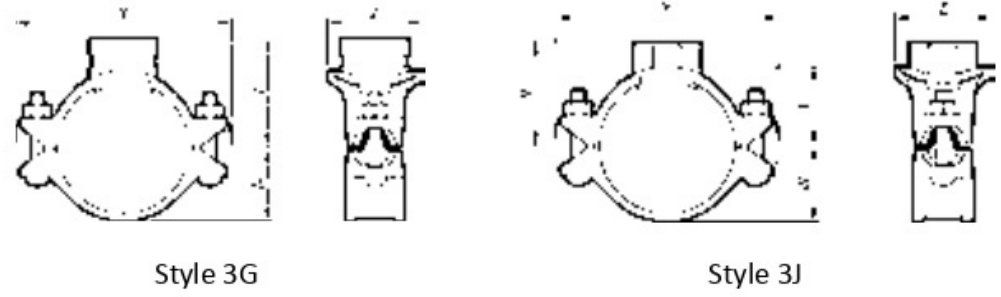

Style 3G Grooved Outlet Mechanical Tee



Style 3J Threaded Outlet Mechanical Tee



- By using the bolting method, the branch pipe is directly connected with the main pipe without welding
- All products have 21.3mm (1/2") outlets and 26.9mm (3/4") outlets are the same as 33.4mm (1") outlets.
- Enhanced body resists 4 times working pressure.

Size			Max. Work Pressure	Hole Size	Dimensions									Bolt/Nut Size	Approx. Wgt.	
Run Pipe	X	Branch Pipe			W	Y	Z	3G V	3J V	3J T	3C	3R				
mm	X	mm	KPa	mm	mm	mm	mm	mm	mm	mm	mm	mm	kg	kg		
Inches	X	Inches	PSI	Inches	Inches	Inches	Inches	Inches	Inches	Inches	Inches	Inches	Lbs.	Lbs.		
133.0	X	33.4	3450	38	75	239	68	107	97	79	M16X85	2.1	2.03			
		1	500	1.50	2.95	9.41	2.68	4.21	3.82	3.11	3/8X3 3/8	4.63	4.47			
		42.4	3450	44.5	75	239	75	107	100	79	M16X85	2.13	2.17			
		1 1/4	500	1.75	2.95	9.41	2.95	4.21	3.94	3.11	3/8X3 3/8	4.69	4.78			
		48.3	3450	51	75	239	81	107	100	79	M16X85	2.21	2.26			
		1 1/2	500	2.00	2.95	9.41	3.19	4.21	3.94	3.11	3/8X3 3/8	4.87	4.98			
	5	60.3	3450	64	75	239	95	107	104	79	M16X85	2.36	2.47			
		2	500	2.50	2.95	9.41	3.74	4.21	4.09	3.11	3/8X3 3/8	5.20	5.44			
		76.1	3450	70	75	239	103	107	107	79	M16X85	2.58	2.79			
		2 1/2	500	2.75	2.95	9.41	4.06	4.21	4.21	3.11	3/8X3 3/8	5.68	6.15			
		88.9	3450	89	75	239	120	107	111	79	M16X85	2.71	3.04			
		3	500	3.50	2.95	9.41	4.72	4.21	4.37	3.11	3/8X3 3/8	5.97	6.70			
139.7	X	33.4	3450	38	78	232	68	110	100	82	M16X85	2.15	2.08			
		1	500	1.50	3.07	9.13	2.68	4.33	3.94	3.23	3/8X3 3/8	4.74	4.58			
		42.4	3450	44.5	78	232	75	110	103	82	M16X85	2.19	2.23			
		1 1/4	500	1.75	3.07	9.13	2.95	4.33	4.06	3.23	3/8X3 3/8	4.82	4.91			
		48.3	3450	51	78	232	81	110	103	82	M16X85	2.26	2.31			
		1 1/2	500	2.00	3.07	9.13	3.19	4.33	4.06	3.23	3/8X3 3/8	4.98	5.09			
	5	60.3	3450	64	78	232	95	110	107	82	M16X85	2.42	2.53			
		2	500	2.50	3.07	9.13	3.74	4.33	4.21	3.23	3/8X3 3/8	5.33	5.57			
		76.1	3450	70	78	232	103	110	110	82	M16X85	2.65	2.86			
		2 1/2	500	2.75	3.07	9.13	4.06	4.33	4.33	3.23	3/8X3 3/8	5.84	6.30			
		88.9	3450	89	78	232	120	110	114	82	M16X85	2.77	3.1			
		3	500	3.50	3.07	9.13	4.72	4.33	4.49	3.23	3/8X3 3/8	6.10	6.83			
141.3	X	33.4	3450	38	79	234	68	111	99	82	M16X85	2.14	2.07			
		1	500	1.50	3.11	9.21	2.68	4.37	3.90	3.23	3/8X3 3/8	4.71	4.56			
		42.4	3450	44.5	79	234	75	111	102	82	M16X85	2.18	2.22			
		1 1/4	500	1.75	3.11	9.21	2.95	4.37	4.02	3.23	3/8X3 3/8	4.80	4.89			
		48.3	3450	51	79	234	81	111	102	82	M16X85	2.26	2.31			
		1 1/2	500	2.00	3.11	9.21	3.19	4.37	4.02	3.23	3/8X3 3/8	4.98	5.09			
	5	60.3	3450	64	79	234	95	111	106	82	M16X85	2.42	2.52			
		2	500	2.50	3.11	9.21	3.74	4.37	4.17	3.23	3/8X3 3/8	5.33	5.55			
		76.1	3450	70	79	234	103	112	109	83	M16X85	2.63	2.83			
		2 1/2	500	2.75	3.11	9.21	4.06	4.41	4.29	3.27	3/8X3 3/8	5.79	6.23			
		88.9	3450	89	79	234	120	112	113	83	M16X85	2.77	3.1			
		3	500	3.50	3.11	9.21	4.72	4.41	4.45	3.27	3/8X3 3/8	6.10	6.83			
159.0	X	33.4	3450	38	89	251	68	121	111	92	M16X85	2.4	2.3			
		1	500	1.50	3.50	9.88	2.68	4.76	4.37	3.62	3/8X3 3/8	5.29	5.07			
		42.4	3450	44.5	89	251	74	121	113	92	M16X85	2.44	2.47			
		1 1/4	500	1.75	3.50	9.88	2.91	4.76	4.45	3.62	3/8X3 3/8	5.37	5.44			
		48.3	3450	51	89	251	80	121	114	92	M16X85	2.51	2.56			
		1 1/2	500	2.00	3.50	9.88	3.15	4.76	4.49	3.62	3/8X3 3/8	5.53	5.64			
	5	60.3	3450	64	89	251	94	121	117	92	M16X85	2.72	2.82			
		2	500	2.50	3.50	9.88	3.70	4.76	4.61	3.62	3/8X3 3/8	5.99	6.21			
		76.1	3450	70	89	251	103	121	121	92	M16X85	3.09	3.29			
		2 1/2	500	2.75	3.50	9.88	4.06	4.76	4.76	3.62	3/8X3 3/8	6.81	7.25			
		88.9	3450	89	89	251	120	121	124	92	M16X85	3.09	3.42			
		3	500	3.50	3.50	9.88	4.72	4.76	4.88	3.62	3/8X3 3/8	6.81	7.53			
108.0	X	114	3450	114	89	251	146	123	--	92	M16X85	3.44	--			
		4	500	4.50	3.50	9.88	5.75	4.84	--	3.62	3/8X3 3/8	7.58	--			
		114.3	3450	114	89	251	146	123	--	92	M16X85	3.49	--			
	4	4	500	4.50	3.50	9.88	5.75	4.84	--	3.62	3/8X3 3/8	7.69	--			

- **Housing material:** Ductile iron conforming to ASTM A-536, grade 65-45-12.
- **FM Approved & UL Listed:** R.W.P. rated working pressure 300PSI(2.065MPa / 20.65bars)
- **Housing Finish:** Fusion Bonded Epoxy Coated(Optional:Hot Deep Galvanized and Others)
- **Coupling gasket material:** EPDM(Optional:Nitrile NBR,Silicone and Others)
- **Bolts and Nuts:** Heat treated and electro galvanized bolts with oval neck, and heavy duty hexagon nuts. Track head meeting the physical and chemical requirements of ASTM A-449 and physical requirements of ASTM A-183.
- **Size Range:** DN50 X DN25 through DN200 X DN100 (2" X 1" through 8" X 4")

## Mechanical Outlets

### Mechanical Tee

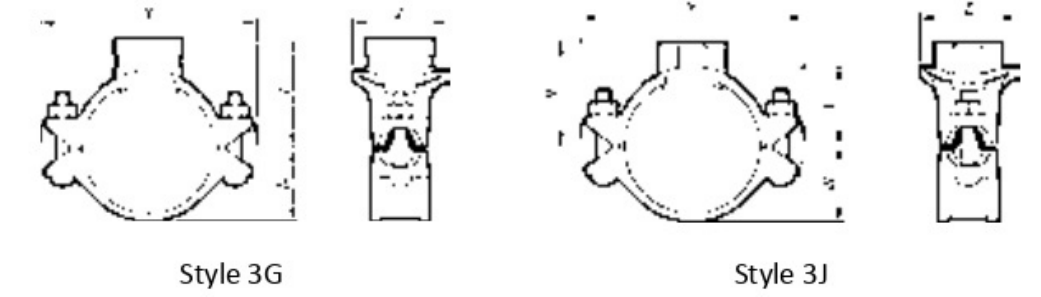

Style 3G Grooved Outlet Mechanical Tee



Style 3J Threaded Outlet Mechanical Tee



- By using the bolting method, the branch pipe is directly connected with the main pipe without welding
- All products have 21.3mm (1/2") outlets and 26.9mm (3/4") outlets are the same as 33.4mm (1") outlets.
- Enhanced body resists 4 times working pressure.

Size			Max. Work Pressure	Hole Size	Dimensions									Bolt/Nut Size	Approx. Wgt.	
Run Pipe	X	Branch Pipe			W	Y	Z	3G V	3J V	3J T	3C	3R				
mm	X	mm	KPa	mm	mm	mm	mm	mm	mm	mm	mm	mm	kg	kg		
Inches	X	Inches	PSI	Inches	Inches	Inches	Inches	Inches	Inches	Inches	Inches	Inches	Lbs.	Lbs.		
165.1	X	33.4	3450	38	95	124	114	92	257	68	M16X85	2.42	2.31			
		1	500	1.50	3.74	4.88	4.49	3.62	10.12	2.68	3/8X3 3/8	5.33	5.09			
		42.4	3450	44.5	95	124	116	92	257	74	M16X85	2.46	2.5			
		1 1/4	500	1.75	3.74	4.88	4.57	3.62	10.12	2.91	3/8X3 3/8	5.42	5.51			
		48.3	3450	51	95	124	117	92	257	80	M16X85	2.53	2.58			
		1 1/2	500	2.00	3.74	4.88	4.61	3.62	10.12	3.15	3/8X3 3/8	5.57	5.68			
	6	60.3	3450	64	95	124	120	92	257	94	M16X85	2.73	2.83			
		2	500	2.50	3.74	4.88	4.72	3.62	10.12	3.70	3/8X3 3/8	6.01	6.23			
		76.1	3450	70	95	124	124	92	257	103	M16X85	2.99	3.1			
		2 1/2	500	2.75	3.74	4.88	4.88	3.62	10.12	4.06	3/8X3 3/8	6.59	6.83			
		88.9	3450	89	95	124	127	92	257	120	M16X85	3.12	3.44			
		3	500	3.50	3.74	4.88	5.00	3.62	10.12	4.72	3/8X3 3/8	6.87	7.58			
168.3	X	33.4	3450	38	97	126	116	94	260	68	M16X85	2.43	2.34			
		1	500	1.50	3.82	4.96	4.57	3.70	10.24	2.68	3/8X3 3/8	5.35	5.15			
		42.4	3450	44.5	97	126	118	94	260	74	M16X85	2.47	2.51			
		1 1/4	500	1.75	3.82	4.96	4.65	3.70	10.24	2.91	3/8X3 3/8	5.44	5.53			
		48.3	3450	51	97	126	119	94	260	80	M16X85	2.53	2.58			
		1 1/2	500	2.00	3.82	4.96	4.69	3.70	10.24	3.15	3/8X3 3/8	5.57	5.68			
	6	60.3	3450	64	97	126	122	94	260	94	M16X85	2.74	2.85			
		2	500	2.50	3.82	4.96	4.80	3.70	10.24	3.70	3/8X3 3/8	6.04	6.28			
		73.0	3450	70	97	126	124	94	260	103	M16X85	2.96	3.15			
		2 1/2	500	2.75	3.82	4.96	4.88	3.70	10.24	4.06	3/8X3 3/8	6.52	6.94			
		88.9	3450	89	97	126	129	94	260	120	M16X85	3.13	3.44			
		3	500	3.50	3.82	4.96	5.08	3.70	10.24	4.72	3/8X3 3/8	6.89	7.58			
219.1	X	33.4	3450	38	123	152	142	121	328	68	M20X115	3.95	3.82			
		1	500	1.50	4.84	5.98	5.59	4.76	12.91	2.68	3/4X4 1/2	8.70	8.41			
		42.4	3450	44.5	123	152	144	121	328	74	M20X115	3.98	4.02			
		1 1/4	500	1.75	4.84	5.98	5.67	4.76	12.91</							



Mechanical Outlets

Mechanical Cross

Mechanical Tee, all the sizes can be combined into a mechanical cross. But it should be in accordance with certain principles of combination, otherwise it will affect pipe strength. This table shows the principle of combination.



★ Can be combined into mechanical cross.  
 ✘ Not recommended to assemble a mechanical cross.

Size			Branch Pipe							
Run Pipe	X	Branch Pipe	33.4 1	42.4 1 1/4	48.3 1 1/2	60.3 2	73.0 2 1/2	76.1 2 1/2	88.9 3	
73.0 2 1/2	X	33.4 1	★	★	★					
		42.4 1 1/4	★	★	★					
		48.3 1 1/2	★	★	✘					
76.1 2 1/2	X	33.4 1	★	★	★					
		42.4 1 1/4	★	★	★					
		48.3 1 1/2	★	★	✘					
88.9 3	X	33.4 1	★	★	★	★				
		42.4 1 1/4	★	★	★	★				
		48.3 1 1/2	★	★	★	★				
		60.3 2	★	★	★	✘				
108.0 4	X	33.4 1	★	★	★	★		★		
		42.4 1 1/4	★	★	★	★		★		
		48.3 1 1/2	★	★	★	★		★		
		60.3 2	★	★	★	★		✘		
114.3 4	X	33.4 1	★	★	★	★	★	★	★	
		42.4 1 1/4	★	★	★	★	★	★	★	
		48.3 1 1/2	★	★	★	★	★	★	★	
		60.3 2	★	★	★	★	✘	✘	✘	
		73.0 2 1/2	★	★	★	✘	✘	✘	✘	
		76.1 2 1/2	★	★	★	✘	✘	✘	✘	
		88.9 3	★	★	★	✘	✘	✘	✘	
133.0 5	X	33.4 1	★	★	★	★		★	★	
		42.4 1 1/4	★	★	★	★		★	★	
		48.3 1 1/2	★	★	★	★		★	★	
		60.3 2	★	★	★	★		★	★	
		76.1 2 1/2	★	★	★	★		★	✘	
		88.9 3	★	★	★	★		✘	✘	
139.7 5	X	33.4 1	★	★	★	★		★	★	
		42.4 1 1/4	★	★	★	★		★	★	
		48.3 1 1/2	★	★	★	★		★	★	
		60.3 2	★	★	★	★		★	★	
		76.1 2 1/2	★	★	★	★		★	✘	
		88.9 3	★	★	★	★		✘	✘	

Size		Branch Pipe									
Run Pipe	X	Branch Pipe	33.4 1	42.4 1 1/4	48.3 1 1/2	60.3 2	73.0 2 1/2	76.1 2 1/2	88.9 3	108.0 4	114.3 4
141.3 5	X	33.4 1	★	★	★	★	★		★		
		42.4 1 1/4	★	★	★	★	★		★		
		48.3 1 1/2	★	★	★	★	★		★		
		60.3 2	★	★	★	★	★		★		
		73.0 2 1/2	★	★	★	★	★		✘		
		88.9 3	★	★	★	★	✘	✘	✘		
159.0 6	X	33.4 1	★	★	★	★		★	★	★	★
		42.4 1 1/4	★	★	★	★		★	★	★	★
		48.3 1 1/2	★	★	★	★		★	★	★	★
		60.3 2	★	★	★	★		★	★	★	★
		76.1 2 1/2	★	★	★	★		★	★	★	★
		88.9 3	★	★	★	★		★	★	✘	✘
		108.0 4	★	★	★	★		★	✘	✘	✘
		114.3 4	★	★	★	★		★	✘	✘	✘
165.1 6	X	33.4 1	★	★	★	★		★	★	★	★
		42.4 1 1/4	★	★	★	★		★	★	★	★
		48.3 1 1/2	★	★	★	★		★	★	★	★
		60.3 2	★	★	★	★		★	★	★	★
		76.1 2 1/2	★	★	★	★		★	★	★	★
		88.9 3	★	★	★	★		★	★	✘	✘
		108.0 4	★	★	★	★		★	✘	✘	✘
		114.3 4	★	★	★	★		★	✘	✘	✘
168.3 6	X	33.4 1	★	★	★	★	★		★		★
		42.4 1 1/4	★	★	★	★	★		★		★
		48.3 1 1/2	★	★	★	★	★		★		★
		60.3 2	★	★	★	★	★		★		★
		76.1 2 1/2	★	★	★	★	★		★		★
		88.9 3	★	★	★	★	★		★		★
		108.0 4	★	★	★	★	★		★		✘
		114.3 4	★	★	★	★	★		★		✘
219.1 8	X	33.4 1	★	★	★	★	★	★	★	★	★
		42.4 1 1/4	★	★	★	★	★	★	★	★	★
		48.3 1 1/2	★	★	★	★	★	★	★	★	★
		60.3 2	★	★	★	★	★	★	★	★	★
		73.0 2 1/2	★	★	★	★	★	★	★	★	★
		76.1 2 1/2	★	★	★	★	★	★	★	★	★
		88.9 3	★	★	★	★	★	★	★	★	★
		108.0 4	★	★	★	★	★	★	★	★	★
		114.3 4	★	★	★	★	★	★	★	★	★

OFFERED BY - SKS VALVES

Mechanical Outlets

Mechanical Tee

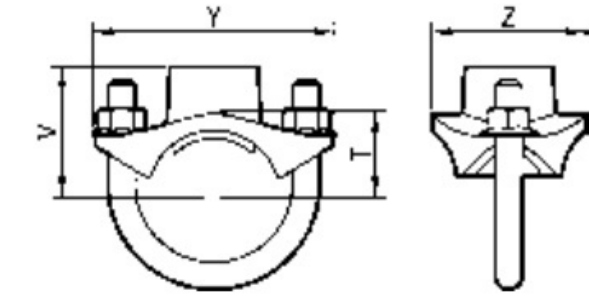

Style 3L U-bolt Mechanical Tee



- U-bolt replaces cover part, without welding, directly from the main pipe branch
- Enhanced body resists 4 times working pressure.

Size			Max Work Pressure	Hole Size	Dimensions				Bolt/Nut Size	Approx. Wgt.
Run Pipe	X	Branch Pipe			Y	Z	V	T		
mm	X	mm	KPa	mm	mm	mm	mm	mm	mm	kg
Inches	X	Inches	PSI	Inches	Inches	Inches	Inches	Inches	Inches	Lbs.
42.4	X	21.3	2500	30.5	88	57	46	28	M10 X 68 X 38	0.32
1 1/4		1/2	350	1.20	3.46	2.25	1.81	1.10	3/8 X 2 11/16 X 1 1/2	0.70
		26.9	2500	30.5	88	57	46	30	M10 X 68 X 38	0.34
		3/4	350	1.20	3.46	2.25	1.81	1.81	3/8 X 2 11/16 X 1 1/2	0.75
33.4		2500	30.5	88	57	52	34	M10 X 68 X 38	0.40	
1		350	1.20	3.46	2.25	2.05	1.34	3/8 X 2 11/16 X 1 1/2	0.88	
48.3	X	21.3	2500	30.5	88	57	45	31	M10 X 68 X 38	0.32
1 1/2		1/2	350	1.20	3.46	2.25	1.77	1.22	3/8 X 2 11/16 X 1 1/2	0.70
		26.9	2500	30.5	88	57	48	33	M10 X 68 X 38	0.34
		3/4	350	1.20	3.46	2.25	1.89	1.30	3/8 X 2 11/16 X 1 1/2	0.75
33.4		2500	30.5	88	57	55	37	M10 X 68 X 38	0.40	
1		350	1.20	3.46	2.25	2.17	1.46	3/8 X 2 11/16 X 1 1/2	0.88	
60.3	X	21.3	2500	30.5	94	57	51	37	M10 X 74 X 47	0.33
2		1/2	350	1.20	3.70	2.25	2.00	1.46	3/8 X 2 15/16 X 1 7/8	0.73
		26.9	2500	30.5	94	57	54	39	M10 X 74 X 47	0.35
		3/4	350	1.20	3.70	2.25	2.13	1.54	3/8 X 2 15/16 X 1 7/8	0.77
33.4		2500	30.5	94	57	61	43	M10 X 74 X 47	0.41	
1		350	1.20	3.70	2.25	2.40	1.69	3/8 X 2 15/16 X 1 7/8	0.90	
73	X	21.3	2500	30.5	108	57	57	43	M10 X 89 X 57	0.33
2 1/2		1/2	350	1.20	4.25	2.25	2.25	1.69	3/8 X 3 1/2 X 2 1/4	0.73
		26.9	2500	30.5	108	57	60	45	M10 X 89 X 57	0.35
		3/4	350	1.20	4.25	2.25	2.36	1.77	3/8 X 3 1/2 X 2 1/4	0.77
33.4		2500	30.5	108	57	67	49	M10 X 89 X 57	0.41	
1		350	1.20	4.25	2.25	2.64	1.93	3/8 X 3 1/2 X 2 1/4	0.90	
76.1	X	21.3	2500	30.5	108	57	59	45	M10 X 89 X 57	0.33
2 1/2		1/2	350	1.20	4.25	2.25	2.32	1.77	3/8 X 3 1/2 X 2 1/4	0.73
		26.9	2500	30.5	108	57	62	47	M10 X 89 X 57	0.35
		3/4	350	1.20	4.25	2.25	2.44	1.85	3/8 X 3 1/2 X 2 1/4	0.77
33.4		2500	30.5	108	57	69	51	M10 X 89 X 57	0.41	
1		350	1.20	4.25	2.25	2.72	2.00	3/8 X 3 1/2 X 2 1/4	0.90	

- Housing material: Ductile iron conforming to ASTM A-536, grade 65-45-12.
- FM Approved & UL Listed: R.W.P. rated working pressure 300PSI(2.065MPa / 20.65bars)
- Housing Finish: Fusion Bonded Epoxy Coated(Optional: Hot Deep Galvanized and Others)
- Coupling gasket material: EPDM(Optional: Nitrile NBR, Silicone and Others)
- Bolts and Nuts: Heat treated and electro galvanized bolts with oval neck, and heavy duty hexagon nuts. Track head meeting the physical and chemical requirements of ASTM A-449 and physical requirements of ASTM A-183.
- Size Range: DN32 X DN15 through DN65 X DN25 (1 1/4" X 1/2" through 2 1/2" X 1")







## Rubber Gasket



CNG gaskets are designed to provide life-of-the-system service in a wide variety of applications. Gasket materials are available to meet most piping applications. For a list of service recommendations by gasket type see pg 45-47

## Rubber Gasket Styles

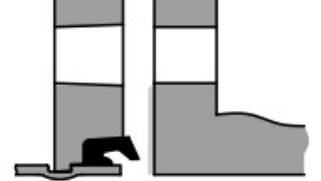
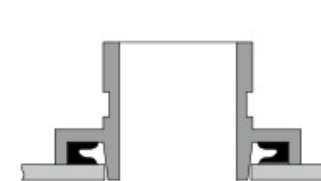
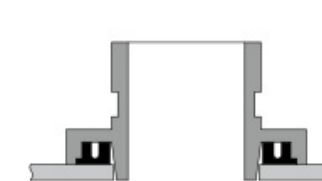
 <p><b>Standard C type:</b> Usually with grooved fittings. 1GS, 1X, 1N, 1NH, such as no special requirements are supporting this type of rubber seals</p>	 <p><b>E type :</b> Usually with grooved fittings. 1GS, 1X, 1N, 1NH can be matched with this type of rubber seal</p>	 <p><b>Reducing type :</b> Usually with grooved reducing fitting. 1NR supporting this type of rubber ring.</p>
 <p><b>Flange type:</b> 321-type slip flange are matched with this type of rubber ring</p>	 <p><b>Opening reaction type:</b> 3G, 3J are optional matching this type of rubber ring</p>	 <p><b>Hole labyrinth type:</b> 3G, 3J are optional matching this type of rubber ring</p>

## Rubber Gasket Materials

As elastomer technology advanced, superior gasket materials became available and were added to the CNG line. This allows CNG to presently offer a variety of synthetic rubber gaskets to provide the option of selecting CNG products for the widest variety of applications. For most water system piping applications, CNG grade EPDM rubber is recommended. CNG E-grade rubber gasket material with excellent performance in anti-aging and heat resistance, the material at 125 °C (257°F) temperature, the material for hot air aging test, the physical properties of the basic unchanged. When the rubber in a non-air environment, such as water piping system, its anti-aging properties will be further strengthened. Since water has no deteriorating effect on the elastomer, temperature is the only limiting factor to be considered in determining the life expectancy of the elastomer in water service. The superior performance of the Grade "E" elastomer permits its use for hot water service up to +230°F/+110°C . The Grade "E" gasket is superior to previous gasket materials by all performance barometers, including high and low temperature limits, tensile strength, chemical resistance and shelf life.

## Rubber Gasket Date

To assure the maximum life for the service intended, proper gasket selection and specification in ordering is essential. Many factors must be considered in determining the optimum gasket for a specific service. The foremost consideration is temperature , along with concentration of product, duration of service and continuity of service. Temperatures beyond the recommended limits have a degrading effect on the polymer. Therefore, there is a direct relationship between temperature, continuity of service and gasket life. Services listed are General Service Recommendations only. It should be noted that there are services for which these gaskets are not recommended. For a list of application-specific and non-recommended application recommendations, reference should be made to the latest selection guide for seals. The use of gasket only for the selection of rubber materials in the product, does not involve the selection of metal shell, fittings and bolts and nuts. For the housing, accessories and bolts and nuts selection, should be selected according to the actual application environment.

## Rubber Gasket Lubricant

When installing the product, the outer surface of the gasket should be lubricated, this will help prevent the gasket from being crushed during installation. It is recommended to lubricate the outer surface of the gasket, including the lip and / or tube end, and the housing cavity, and the lubricated aprons surface will help to properly install the product. Under normal circumstances recommended the use of special lubricants, if necessary, consult the relevant CNG institutions. Also available household human body can be directly exposed to the washing products, add water after modulation, such as detergents, soap, detergent, etc., avoid using mechanical lubricants, such as butter and so on.

 **Warning**

To ensure that the rubber seal in the application of the longest life expectancy, the correct choice when ordering rubber seal material and specifications are the most basic requirements. Failure to select the right rubber seal material can result in personal injury or property damage, joint leakage, or connection failure.

## Rubber Gasket Materials

The material of the gasket must be determined according to the characteristics of the fluid medium. The commonly used sealing rings are shown in the following table :

Grade	Temperature Range	Rubber Compound	Color Code	General Service Recommendations
E	-30°F to +230°F -34°C to +110°C	EPDM	Green Stripe	Recommended for hot water service within the specified temperature range plus a variety of dilute acids, oil-free air and many chemical services. UL classified in accordance with ANSI/NSF 61 for cold +86°F/+30°C and hot +180°F/+82°C potable water service. NOT RECOMMENDED FOR PETROLEUM SERVICES.
T	-20°F to +180°F -29°C to +82°C	Nitrile	Orange Stripe	Recommended for petroleum products, hydrocarbons, air with oil vapors, vegetable and mineral oils within the specified temperature range; except hot dry air over +140°F/+60°C and water over +150°F/+66°C. NOT RECOMMENDED FOR HOT WATER SERVICES.
O	-20°F to +300°F -29°C to +149°C	Fluoroelastomer	Blue Stripe	Recommended for many oxidizing acids, petroleum oils, halogenated hydrocarbons, lubricants, hydraulic fluids, organic liquids and air with hydrocarbons to +300°F/+149°C.
L	-30°F to +350°F -34°C to +177°C	Silicone	white	Recommended for dry heat, air without hydrocarbons to +350°F/+177°C and certain chemical services.
V	-30°F to +180°F -34°C to +82°C	Neoprene	Yellow Stripe	Recommended for hot lubricating oils and certain chemicals. Good oxidation resistance. Will not support combustion.

For specific compound and temperature compatibility, see this book Chemical Application Table

# Pipe Preparations

# Standard Pipe Wall thickness

Standard pipe wall thickness(including GB/T 3091、ANSI B36.10/B36.19)

Size		GB/T 3091		ANSI B36.10/B36.19								
Nominal Dia.	Actual O.D.	Std.	Thicken	Sch. 5S	Sch. 5	Sch. 10S	Sch. 10	Sch. 20	Sch. 30	Sch. 40	Sch. Std.	Sch. 80
DN Inches	mm Inches	mm Inches	mm Inches	mm Inches	mm Inches	mm Inches	mm Inches	mm Inches	mm Inches	mm Inches	mm Inches	mm Inches
20	26.9	2.8	3.5	1.65	1.65	2.11	---	---	---	2.87	2.87	3.91
3/4	1.050	0.110	0.138	0.065	0.065	0.083	---	---	---	0.113	0.113	0.154
25	33.4	3.2	4.0	1.65	1.65	2.77	---	---	---	3.38	2.87	4.55
1	1.315	0.126	0.157	0.065	0.065	0.109	---	---	---	0.133	0.113	0.179
32	42.4	3.5	4.0	1.65	1.65	2.77	---	---	---	3.56	3.56	4.85
1 1/4	1.660	0.138	0.157	0.065	0.065	0.109	---	---	---	0.14	0.14	0.191
40	48.3	3.5	4.5	1.65	1.65	2.77	---	---	---	3.68	3.68	5.08
1 1/2	1.900	0.138	0.177	0.065	0.065	0.109	---	---	---	0.145	0.145	0.2
50	60.3	3.8	4.5	1.65	1.65	2.77	---	---	---	3.91	3.91	5.54
2	2.375	0.150	0.177	0.065	0.065	0.109	---	---	---	0.154	0.154	0.218
65	73.0	---	---	2.11	2.11	3.05	---	---	---	5.16	5.16	7.01
2 1/2	2.875	---	---	0.083	0.083	0.12	---	---	---	0.203	0.203	0.276
65	76.1	4.0	4.5	---	---	---	---	---	---	---	---	---
2 1/2	3.000	0.157	0.177	---	---	---	---	---	---	---	---	---
80	88.9	4.0	5.0	2.11	2.11	3.05	---	---	---	5.49	5.49	7.62
3	3.500	0.157	0.197	0.083	0.083	0.12	---	---	---	0.216	0.216	0.3
90	101.6	---	---	2.11	2.11	3.05	---	---	---	5.74	5.74	8.08
3 1/2	4.000	---	---	0.083	0.083	0.12	---	---	---	0.226	0.226	0.318
100	114.3	4.0	5.0	2.11	2.11	3.05	---	---	---	6.02	6.02	8.56
4	4.500	0.157	0.197	0.083	0.083	0.12	---	---	---	0.237	0.237	0.337
125	139.7	4.0	5.5	---	---	---	---	---	---	---	---	---
5	5.500	0.157	0.217	---	---	---	---	---	---	---	---	---
125	141.3	---	---	2.77	2.77	3.4	---	---	---	6.55	6.55	9.53
5	5.563	---	---	0.109	0.109	0.134	---	---	---	0.258	0.258	0.375
150	168.3	4.5	6.0	2.77	2.77	3.4	---	---	---	7.11	7.11	10.97
6	6.625	0.177	0.236	0.109	0.109	0.134	---	---	---	0.28	0.28	0.432
200	219.1	---	---	2.77	2.77	3.76	---	6.35	7.04	8.18	8.18	12.7
8	8.625	---	---	0.109	0.109	0.148	---	0.25	0.277	0.322	0.322	0.5
250	273.0	---	---	3.4	3.4	4.19	---	6.35	7.8	9.27	9.27	15.09
10	10.750	---	---	0.134	0.134	0.165	---	0.25	0.307	0.365	0.365	0.594
300	323.9	---	---	3.96	3.96	4.57	---	6.35	8.38	10.31	9.53	17.48
12	12.750	---	---	0.156	0.156	0.18	---	0.25	0.33	0.406	0.375	0.688

**OFFERED BY -**



**Delhi, India**

**Ph: 01143211999**